

**The Lowland Dry Zone
of Sri Lanka;
Site for Study
of Aquaculture Development within Farmer-managed Irrigation
Systems and
Methodology for Participatory
Situation Appraisal.**

**Working Paper SL1.1.
Project R7064
2000**

**By
F.J. Murray & D. C.Little.**

Preface & Acknowledgements

These working papers are interim components of a UK Department for International Development (DFID) funded natural resources research program R7064, currently operational in Sri Lanka and Southern India. The project is of 3 years duration from 1999-2002 and aims to investigate the potential for integrated aquaculture options within small-scale farmer managed irrigation systems to bring benefits to marginal groups within diverse, risk-prone semi-arid and water-stressed regions of the world. Benefits are expected to be increased opportunities for livelihood diversification and more efficient and sustainable use of dwindling per capita water supplies.

Principle collaborators are the Institute of Aquaculture, Stirling University, UK, and in Sri Lanka the Agribusiness Centre of Peradeniya University and CARE international. The latter have also provided generous in-country financial support.

Acknowledgement also goes to the following dedicated research staff: Mr LM Gunewardene, Yasanthe Navaratne, Harsha Balsooria, Bandara Samarakoon and Priantha Jayakodi.

All statements of fact or opinion in this document should be taken as interim statements. The work is continuing and matters covered in this report may be revised in the light of future information received. The document has been prepared to provide information exchange within the research team and with counterparts elsewhere. Comments or requests for further information are invited and should be sent to the project leaders in UK or Sri Lanka listed below:

Dr. David Little,
Institute of Aquaculture,
University of Stirling,
Stirling FK9 4LA
UK

e-mail: d.c.little@stirling.ac.uk

Ms. Nilu Gunasekera
CARE International Sri Lanka
134 Havelock Road
Colombo 5
Sri Lanka

e-mail: nilu@care.lanka.net

Mr. Francis Murray,
Institute of Aquaculture
University of Stirling
Stirling FK9 4LA
UK

e-mail: smallface@bigfoot.com

Dr. Sarath S Kodithuwakku,
Agribusiness Center
University of Peradeniya,
Peradeniya
Sri Lanka

e-mail: sarath@abc.pdn.ac.lk

Project background

Arid and semi-arid regions of Southern India and the lowland Dry-zone of Sri Lanka are representative of water-stressed areas experiencing erratic seasonal water availability, high rates of land degradation and chronic poverty. It is estimated that almost half the world's poorest people, nearly 500 million, live in such drought prone-areas and depend on irrigated agriculture to provide them with much of their food supply (UNDP 1997). This will rise to 20% of the world's population by 2050 (Engelman and Leroy 1993). Increasing frequency of drought and competition for water with industrial and domestic users will combine to make water a dwindling per capita resource in these areas. It has been predicted that both India and Sri Lanka will face a fresh-water crisis in the near future (Nigam et al, 1998). Much water is currently wasted due to inadequate management and conservation practices. World-wide irrigation efficiency¹ may be as low as 37% (Postel 1996) and there is a need for more integrated approaches to water management which take into account its multiple uses for purposes besides irrigation (Gowing 1998, Redding 1990). Since agriculture is responsible for some 70% of global water use (FAO 1995), the potential for water savings through multiple use, including aquatic production is enormous.

An emerging development priority has emerged following a paradigm shift where irrigation systems are being reassessed as components of the whole water basin. It is now realized that water and land management practices at the wider watershed level can lead to increased options for on-farm water management at the individual level (Pretty 1995). Watershed development is a huge development initiative in Sub-Saharan Africa, India and other semi-arid areas of the world and often involves the construction of large numbers of small community or farmer-managed water bodies for rainfall harvesting, groundwater recharge and the prevention of soil erosion. In Sri Lanka, as in many parts of India, traditional watershed management exists in the form of the ancient community-managed cascade tank systems. Large-scale rehabilitation of tank systems has taken place over recent decades in both countries.

Two thirds of the predicted shortfall in world fish production (20-30 million tonnes by the year 2000) will occur in the semi-arid tropics (FAO 1995), further underlining the need for such research effort. Despite this potential, attempts to integrate fish production into these water bodies have been rare and usually based on conventional commercial semi-intensive pond aquaculture. Whilst the resource-rich have been able to adopt such an approach, it has proved inappropriate for poorer marginalised groups. By investigating aquaculture options for both traditional and modern watershed development structures, the research results are likely to have broad applicability.

Although large-scale irrigation systems supply the greatest area of farmland, the greatest numbers of farmers still cultivate in rain-fed dry lands, where they rely on small-scale systems. Furthermore the scope for further expansion of large-scale systems is limited, whilst great potential exists to increase the availability of smaller systems through the adoption of watershed development programmes, which include water-harvesting components.

The project aims are to identify social and bio-economic constraints to the integration of aquaculture into farmer-managed irrigation systems and to develop and promote effective approaches to aquaculture for farmers in diverse risk prone dry-land regions of India and Sri Lanka. Intended beneficiaries are the rural poor. Within this group, opportunities for landless, lower caste unemployed youth and women's groups, all of whom have traditionally derived least, benefit from irrigation developments, will be given special consideration. The project has sought to promote a participatory approach to the design and implementation of targeted research. Research outputs include technical guidelines to engineers, policy guidelines to planners and donors, research guidelines to scientists and extension guidelines to field-level

¹ The percentage of irrigation water actually consumed by crops during their growth.

implementers. The closely linked DFID KAR² engineering programme (R7123) is investigating the potential for integrating aquaculture into larger formally managed irrigation systems of semi-arid areas in contiguous research areas.

This series of working papers is based on field research that took place during December and January 1998. The social, economic and technical feasibility of fish production in such systems were investigated and some preliminary constraints to the uptake of poverty focused aquaculture identified. Research included a 'Rapid Rural Appraisal' of two cascade systems in Puttalam and Kurunegala districts (incorporating a total of 21 tanks and 9 villages), and semi-structured interviews with representatives of Government fisheries departments, fisherman's co-operatives, marketing agents and other relevant institutional organisations throughout the country.

Field work was undertaken in collaboration with the, field staff of the NGO's CARE³ IFAD⁴ the Government 'Samurdhi' welfare programme and the Agricultural Economics department and Agribusiness Centre (AbC) of Peradeniya University.

List of working papers in the series:

SL1.1 The Lowland Dry Zone of Sri Lanka; Site for Study of Aquaculture Development within Farmer-managed Irrigation Systems and Methodology for Participatory Situation Appraisal.

SL1.2 Inland Fisheries Resources and The Current Status of Aquaculture in Sri Lanka and North West Province.

SL1.3 The Nature of Small-Scale Farmer Managed Water Resources in North West Province, Sri Lanka and Their Potential for Aquaculture.

SL1.4 Fisheries Marketing Systems and Consumer Preferences in Regional and Sub-Regional Markets of Sri-Lanka.

² Knowledge And Research

³ Caring About Relief Everywhere

⁴ International Fund for Agricultural Development

Glossary

AER	Agro Ecological Region
ARP	Aquaculture Research Programme (DFID)
CARE	Caring About Relief Everywhere (US NGO)
CBO	Community Based Organisation
DS	Divisional Secretariat (local government administrative division)
DFID	Department For International Development
IFAD	International fund for Agricultural Development
KAR	Knowledge and Research (DFID development branch)
LHG	Low Humic Gley
LDZ	Low-Land Dry Zone
LGP	Length of growing period
GDI	Gender Development Index
GEI	Gender Empowerment Index
GN	Grama Nilhadari (village level administrative office)
GoSL	Government of Sri Lanka
Ha	Hectare (= 2.47 acres)
HDI	Human Development Index
HPI	Human Poverty Index
Maha	Main cultivation season (October – March)
NERS	Non Equilibrium Resource System
NGO	Non Governmental Organisation
NWP	North West Province
PET	Potential Evapo-Transpiration
PRA	Participatory Rural Appraisal
<i>Pradeshiya Sabha</i>	Rural local Government (lowest tier)
RBE	Reddish Brown Earth
RRA	Rapid Rural Appraisal
Rs	Rupees (Sri Lankan unit of currency; \$1 = Rs 65)
<i>Samurdhi</i>	Government welfare programme
SAT	Semi Arid Tropics
STC	Small Tank Cascade System
UNDP	United Nations Development Programme
Yala	Secondary cultivation season (April – June)

Executive Summary

The aims of this paper are twofold. Firstly to characterise rural poverty and to give a broad overview of the agro-ecological, climatic and socio-economic conditions in Sri Lanka which shape poverty. Secondly to present the methodology employed to screen suitable field research areas and the techniques subsequently used to carry out Rapid Rural Appraisal in two upper-watersheds villages. Also presented are details of a concurrent stakeholder analysis that aimed to investigate the capacity of secondary stakeholders to promote sustainable aquatic resource development and to invite their participation in the formulation of a participatory research agenda.

Together these components constitute a participatory situation analysis, which is the first step to investigating the social, economic and technical feasibility of poverty focused aquaculture options in small-scale farmer managed irrigation systems in the Lowland Dry Zone (LDZ) of Sri Lanka. Details of the DFID Livelihoods framework to which the programme has subsequently adopted are also presented.

A functional rationale for the classification of irrigation systems with respect to poverty focused livelihood potentials is presented. Small-scale systems are either farmer or community managed and exhibit a high range of seasonality relying on rainfall harvested within their own catchments. By contrast, large-scale systems are managed by external institutions and benefit from assured water supplies often with trans-basin diversions.

With a land area of some 65,000km², the island is characterised by a central massif, surrounded to the north south and east by the Low Land Dry Zone, where the dominant soil type is free draining Reddish Brown Earth (RBE). The island experiences a semi-humid tropical climate, characterised by a bi-modal monsoon rainfall patterns with total rainfall in the Dry Zone averaging between of 625 – 1900 mm per annum. Rainfall is highly erratic between seasons and years. An analyses of rainfall patterns within the research area over the last 30 year normal period, reflects an increasing frequency of drought, currently averaging one year in three.

The island benefits from a vast legacy of man-made irrigation resources, which have shaped life in the Dry zone. Agriculture remains the mainstay of rural livelihoods in the Dry-Zone, yet the sector continues to stagnate due to a cultural attachment to increasingly uneconomical paddy production. This is a consequence of minuscule land holdings, historically low world rice prices, poor market infrastructure, volatile government trade policy and a low-risk dependency culture which has seen farmers under village tanks revert back to subsistence production combined and increasingly to off-farm livelihood strategies.

Poverty in Sri Lanka is still largely a rural phenomenon. Although the distribution of poverty is erratic, levels increase generally with distance traveled away from the well-developed west coast and it's capital city Colombo. In the Dry-zone some of the most marginalised groups, often of low caste status live in upper-watersheds of rainfed cascade systems. Despite Sri Lanka's distinctive human development pattern with good health and education indicators, stunting and wasting due to inadequate diet is still a major problem amongst many rural children which compromises their development for life.

An analysis of institutional capacity in the country shows that the existing administrative structure is inimical to the growth of effective local government. Despite an outwardly democratic appearance the administration remains highly centralised modeled on a command and control colonial legacy. In the postcolonial era, lack of accountability has facilitated the emergence of political patronage networks and communalism. This in turn has resulted in the erosion of many traditional Community Based Organisations (CBOs) and stifled the

emergence of any countervailing civil society focused on needs based community issues as opposed to generic ideologies. The continuing proliferation of overlapping ministerial portfolios, competition and lack of any vertical or horizontal integration between the many line agencies with responsibility for water management are seen as major constraints to sustainable development of commonly held property resources including village tanks.

Identification of field research areas resolved from Provincial to District to Divisional to Cascade level. Resolution to District level was based on centralised aggregate secondary data, and to cascade level on disaggregate data obtained from local government offices. Finally rapid screening of 13 cascade systems was based on field visits, and resulted in two systems being selected for Rapid Rural Appraisal (RRA). The reliability of much of the disaggregate data proved was poor. In the final analysis, the best and simplest results were obtained from an analyses of 1:50,000 ordinance survey maps which gave a good indication of the distribution of the water resource, whilst information sourced from District Medical Officers, including infant mortality and infant nutritional status proved the most reliable proxy of poverty status. Finally, detailed RRAs were undertaken in Danduwelawe and Pahala Diulwewa upper-watershed villages in each of the respective cascades. Key-informant interviews and cascade walks were used to characterise the rest of the systems at lower levels of resolution.

The participatory approaches favoured by donors aim to empower beneficiaries by involving them as far as possible at all stages of the development process. RRA and PRA are two such methodologies employed to produce a swift overview of resource availability, local perceptions and priorities, which can be immediately fed back to the community. Because of time constraints RRA techniques, though more extractive, were favoured over PRA techniques, which require participants to become more deeply involved in data collection and analyses. Participatory tools employed included semi-structured interviews, ranking and scoring of priorities, wealth ranking, farm and cascade walks, social and watershed mapping. Group meetings were held in each village to introduce the project and to facilitate focus-group activities including the identification of ranking and scoring criteria. Villagers were asked to identify the selection criteria for fish, fish and meat substitute preferences, uses of village tank resources and perceived constraints to aquaculture. The resulting criteria were then incorporated in semi-structure questionnaire, which was administered to a total of over 40 households according to a wealth-ranked, stratified sampling regime. From the results of ranking and scoring exercises, the level of agreement between respondents and as well as the relative importance of the ranked parameters were assessed using Moods Median test and the Friedman test, two simple non-parametric statistical methods. Results of these analyses are presented in other Working Papers in the series.

Finally the collected results of the situation analyses, including secondary data, outputs of the (secondary) stakeholder workshop and RRA findings amongst the primary stakeholders were used to formulate a participatory research agenda. These identified hypotheses based on the concept of improving the livelihoods of poorer groups through enhancing fish production by in-situ production of fingerlings in seasonal upper-watershed tanks using locally available seeds and broodstocks.

Table of Contents

Preface & Acknowledgements.....	ii
List of working papers in the series:.....	iv
Glossary	v
Executive Summary.....	vi
Table of Contents	viii
List of Tables.....	ix
List of Figures.....	ix
List of Boxes.....	ix
1 The project framework.....	1
1.1 Introduction.....	1
1.2 Participatory situation analyses.....	1
1.3 Stakeholder workshops:.....	2
2 Scope of the project.....	3
2.1 Water stressed regions:.....	3
2.2 Classification of irrigation systems and aquaculture potentials	4
2.3 Watershed management:.....	5
3 Background to the research areas in Sri Lanka	6
3.1 Introduction.....	6
3.2 Irrigation	7
3.3 Agriculture and the economy	8
3.4 Human development and poverty in Sri Lanka	8
3.4.1 The ethnic conflict and human development	10
3.5 Government administration in Sri Lanka.....	11
3.5.1 The administrative structure.....	11
3.5.2 Institutional capacity	12
3.6 Physical and climatic Characteristics of the Study area.....	15
3.6.1 Agro-Ecology	15
3.6.2 Soils and Agricultural Land Use.....	17
3.6.3 Climate.....	18
4 Methodology	22
4.1 Participatory methods:.....	22
4.1.1 Data validity.....	23
4.2 The Research Framework.....	25
4.3 Determination of field areas for in-depth research:	26
4.3.1 Participatory data collection.....	29
4.3.2 Participatory mapping of watersheds, water availability & quality analysis.....	30
4.4 Statistical analysis:.....	30
4.5 Recommendations for participatory information gathering and analyses.	31
5 Preliminary researchable hypotheses.....	32
References.....	35
Appendix 1: The sustainable livelihoods framework:	38
Appendix 2 Summary tables of climatic data.....	39
Appendix 3: Poverty indicators for districts within the lowland dry zone.....	40
Appendix 4: Poverty and water resource indicators for divisional secretariats of North West, North Central and Northern Provinces.	41
Appendix 5: Key to locations included in cascade screening process.....	43
Appendix 6: Map showing location of cascade systems selected for in-depth study and Divisional secretariats of Kurunegala and Puttalam Districts	44
Appendix 7: The Mahaweli development programme	45
Appendix 8: Location of irrigation components of the Mahaweli Development Programme ..	46
Appendix 9: Summary procedure for computing the Friedman 2-way analysis of variance ...	47
Appendix 10: Statistical Tables of critical values for Friedman's test.....	48

List of Tables

Table 1: The moisture index and LPG1 of various bio-climatic types.....	3
Table 2: Classification and characteristics of small and large-scale irrigation systems.....	4
Table 3: Principle components of integrated watershed development	6
Table 4: District wise GDP and Development Indices in Sri Lanka	9
Table 5: Distinguishing characteristics of Agro-Ecological regions of the dry zone.....	15
Table 6: Characteristics of Red and Black soils in Sri Lanka	17
Table 7: Land utilisation within agricultural holdings in Sri Lanka	17
Table 8: Summary climatic statistics for selected dry-zone stations 1985-1998.....	19

List of Figures

Figure 1: Map of administrative districts of Sri Lanka.....	7
Figure 2: Structure of the Sri Lankan Government and Local Administration.....	12
Figure 3: Map showing agro-ecological regions of Sri Lanka.	16
Figure 4: Map showing annual rainfall distribution in Sri Lanka	19
Figure 5: Mean total annual rainfall 1985 -1998 for selected divisional secretariats in Puttalam, Kurunegala and Anuradhapura Districts.....	20
Figure 6: Mean 30 year (normal) total annual rainfall 1951-1980 & 1961 to 1990 Tirappane GN Division.....	20
Figure 7: Mean monthly rainfall and temperature 1985-1998 for selected GN Divisions in Puttalam, Kurunegala and Anuradhapura Districts	21
Figure 8: Mean district wise water balance 1961-1990 in Sri Lanka	21
Figure 9: The research framework, inc. methodology for identification of field sites.....	25
Figure 10: Flow chart showing resolution from District level to selection of STCs	27
Figure 11: Location of Small Tank Cascade systems (STCs) screened using field visits	28
Figure 12: Envisaged fish movements in a tilapia-based, low-input, enhanced fishery.....	33

List of Boxes

Box 1: Major components of a situation analysis for aquaculture related development.....	2
Box 2: Land and water management issues in the dry zone of Sri Lanka and India	5
Box 3: The role of research in the participatory paradigm	22
Box 4: PRA Tools used in the project field research	23
Box 5: Bias and means of data validation in participatory research	24

1 The project framework

Various frameworks are employed for studying poverty and its reduction. Foremost amongst those currently employed are the following.

- *The poverty line*: Focusing on the threshold income needed to provide basic needs, this is the crudest framework that considers only one of the multiple-dimensions of poverty.
- *Assets-based approaches*: Based on an examination of the assets that poor people have, including; land, water, labour, social networks etc. Access to such assets lessens the vulnerability to natural disasters and economic and together these factors determine the livelihood strategies of the poor. This is the basis of the DFID Livelihoods framework, which underpins this research work.
- *Rights-based approaches*: Drawn from the Human Rights arena and based on an assessment of inequality and injustice this approach focuses on the rights of poor people to freedom from the multiple aspects of poverty. This can be contrasted with traditional development approaches that aimed to facilitate the development of human potentials (UNDP 2000). As one of the most recent approaches to be developed, further clarification is required as to how such an approach could be operationalised.

1.1 Introduction

This paper and the accompanying working papers in the series (page ii.) are presented as part of a wide ranging ‘participatory situation analysis’⁵ (section 1.2). This paper presents the contextual background to the situation analysis followed by a description of the research framework used to gather data. A discussion of the statistical methods used to analyse the collected data and preliminary researchable hypotheses arising from this work are also presented.

1.2 Participatory situation analyses.

Participatory situation analysis is used as the first step to investigating the social, economic and technical feasibility of aquaculture options in small-scale farmer managed irrigation systems in the Lowland Dry Zone (LDZ) of Sri Lanka, with the aim of determining relevant initiatives, which benefit the poor. The principle components of the situation analysis are shown in Box 1. The process progresses from regional to local level, using secondary information and key informant interviews before undertaking Participatory Rural Appraisals (PRA in villages within two Seasonal Tank Cascade Systems of Puttalam and Kurunegala Districts of North West Province. The framework, outlined in Figure 9 includes the following components:

- The screening process used to select field work areas
- The participatory data gathering methodology used in study villages
- Data validation techniques employed

A recent change in policy concerning development assistance from the UK was signalled with the publication of a White Paper⁶ committing the British Department for International Development (DFID) to promoting “Sustainable Livelihoods” while both protecting and improving the management of the natural and physical environment (see Appendix 1). These objectives are expected to contribute to an overall goal of poverty eradication (Carney 1998). The ‘participatory situation analysis’ framework adopted in these papers shares many of the components of the sustainable livelihoods approach, and a summary of both the Sri Lankan and Indian analysis are presented within this framework in a separate Inception report

⁵ This can be defined as the process of supporting local participants to study and reflect on their local situation in order to identify constraints and opportunities for sustainable development.

⁶Eliminating World Poverty; A Challenge for the 21st Century. White Paper on International Development Presented to Parliament by the Secretary of State for International Development by Command of Her Majesty November 1997.

(Felsing, Murray *et al* 1999). The sustainable livelihoods framework will be used to guide future research.

Box 1: Major components of a situation analysis for aquaculture related development (adapted from Haylor, Lawrence and Meusch, 1997).

Regional and local Situation Analysis.

- a) Institutional support:
 - Process orientated: Aquacultural and agricultural information systems, research bodies and support schemes. Policymaking bodies.
 - Action orientated: NGO's, international development organisations, fisheries departments, banking and credit.
- b) Fisheries production (by sector, seasonal & historic), aquaculture development & seed production.
- c) Fisheries marketing (consumer preferences, infrastructure, wholesale and retail systems)
- d) Relevant political and economic situation (i.e. demography, social disintegration).

Local Situation Analysis (Based around Village level PRA and longer term monitoring).

- e) The local economy (labour, sources of income, credit, cash flow).
- f) Physical nature of the area (climate, soils, water bodies).
- g) Patterns of ownership and access to land and water.
- h) Social structure (caste, wealth) of the local community and main priorities of these.
- i) Role of women in farming systems and (resource access and decision making powers)
- j) Farming systems and the role of women in these systems (seasonal patterns, workloads)
- k) Existing indigenous knowledge relevant to research.

1.3 Stakeholder workshops:

As a concurrent component of the situation analysis a stakeholder workshop was held in Kandy during November 1998. *Stakeholder analysis* is a multi-perspective participatory approach, which can be used to investigate the potential interactions, conflicts and trade-offs associated with a particular course of action. A Stakeholder analysis is also an important first step in developing a shared idea of the work to be done and how to go about it, to improve the way work is designed and carried out. In the present context stakeholder analysis was carried out to determine participants' priorities for the formulation of a research agenda, to clarify differences in contribution, expectations and priorities, and to negotiate acceptance of these.

As it was impracticable to bring primary and secondary stakeholders⁷ together within a single forum, the participation workshop was restricted to the latter group; Governmental line agencies, development and research institutions working in the arenas of, irrigation / water management, aquaculture and socio-economics. Outputs of the workshop are presented in a separate report (Murray and Little 1998).

The opinion of primary stakeholders i.e. local communities, was canvassed during subsequent village PRA's. In addition farmers who wished to research aquaculture options on their farms, were invited to participate in a primary stakeholder workshop prior to the following rainy season after which they will be supported to monitor and evaluate such research. This stakeholder forum was therefore used to achieve the following outputs:

- Further elucidation of researchable constraints to identified aquaculture options.
- Design of a monitoring scheme to enable evaluation of the relative success of the approaches adopted by different groups of farmers, as measured by indicators identified by the farmers themselves.

⁷ *Primary stakeholders* tend to live in close proximity to the project location and are likely to be directly affected by the project impacts. Further removed are *secondary stakeholders* who have an interest in the resources affected by the project, or are involved in the delivery or decision-making processes associated with project activities.

- Knowledge about specific aquaculture options for the different water bodies and if necessary, credit assistance for interventions will be made available to informal associations formed by participating farmers.

Preliminary research hypotheses based around a low input enhanced fishery in seasonal tanks are presented in section 9. These intervention options rely on in-situ breeding of tilapias and prey-predator synergies using locally sourced snakehead (see also Working Papers SL1.2 and SL1.3).

2 Scope of the project

2.1 Water stressed regions:

The project aims to investigate the potential for aquaculture in water stressed areas⁸ of the world with erratic and highly seasonal water availability. As a home to a large proportion of the world's poor these regions face a future of scarcity of food and insufficient water for consumption and irrigation of crops. Table 1 shows a classification of nine bio-climatic types identified throughout the world, whose definition relates to information about the monthly and annual balance (surplus or deficit) determining the moisture index (IM) in an area of specific rainfall and potential evapo-transpiration (PET). This project and the linked project in India are working in areas with negative moisture indices and short growing periods (less than 210 and typically less than 150 days under rain-fed conditions).

Climate Classification	Moisture Index	Climate type	Corresponding LPG (days)
E Arid	-66.7 to -100	Arid	< 90
D Semi-arid	-33.3 to - 66.7	Dry	90 – 150
C1 Dry sub-humid	0 to -33.3	Dry	
C2 Moist sub-humid	0 to 20	Dry	150-210
B1 Humid	20 to 40	Dry	
B2 Humid	40 to 60	Moist	
B3 Humid	60 to 80	Moist	>210
B4 Humid	80 to 100	Moist	
A Perihumid	>100	Wet	

¹ Length of growing Period = the period when soil moisture is adequate to support plant growth. The growing period starts when precipitation (P) exceeds 50% of annual potential-evapo-transpiration (PET) and ends with the utilisation of an assumed 100mm of soil moisture after P falls below PET (Higgins & Kassam, 1981)
² Moisture index (IM) = Balance between moisture availability and PET (Bhattacharjee et al 1982)

Extensive subtropical belts stretching around the world (known as the semi-arid tropics or SAT) are characteristic of the first two bio-climatic types and the research areas in India fall under this classification. Sri Lanka is classed as having a tropical humid climate, however this reflects average conditions skewed by high rainfall levels in upland areas. Although the research areas in the lowland Dry zone of Sri Lanka receive higher rainfall levels and have a generally superior water balance (Fig. 8) than the Indian sites, the seasonal distribution and growing periods are almost equally short. The majority of farmers in the world including the poorest farmers in these marginal regions, place great reliance on small-scale irrigation systems to increase the low productivity associated with dry-land cultivation. A detailed description of climatic conditions within the main project research areas is presented in section 3.6.3.

⁸ Facing prolonged periods of acute water-shortage.

2.2 Classification of irrigation systems and aquaculture potentials

In both India and Sri Lanka irrigation systems are categorised for administrative purposes into major and minor systems. In Sri Lanka this classification corresponds with the size of the irrigable area (command area) associated with a system (see Table 2 and Working Paper SL1.3).

However, as the constraints and opportunities for the poor to benefit from integrated production of aquatic organisms in large, institutionally-managed systems is likely to be very different to the potential for farmers to manage various forms of micro-irrigation. We therefore use an administrative categorisation of irrigation as being under the control of (1) the household or immediate community (small-scale) or (2) an outside institution, typically an irrigation authority or department (large-scale). A secondary defining criterion concerns the reliability of the water supply. Large-scale system generally benefit from 'assured' supplies either through their strategic location on perennial rivers or via trans-basin canal diversions. Small-scale systems by contrast are 'rainfed'. That is they rely on rain falling only within their own micro- and meso catchments and hence are characterised by more marked seasonal trends in water availability (Working Paper SL1.3). Under these criteria small-scale irrigation systems are included within the 'minor' and 'micro' conventional administrative categories whilst 'medium' systems may share both large and small-scale properties. Although large-scale irrigation systems cover more surface area and supply a greater area of farmland, most farmers are dependent on small-scale systems for their daily livelihood (Wolf 1986). Other important characteristics of small and large-scale systems are also shown in Table 2.

Table 2: Classification of small and large-scale irrigation systems (from Haylor 1994).

Administrative Classification	Major	Medium	Minor	Micro
Project classification*	Large-scale	Large or Small	Small-scale	Small-scale
Water source	Large dams and canals constructed on perennial rivers.	Reservoirs fed by runoff (or cross basin diversions)	Reservoirs fed by ephemeral surface or ground water	Rain and silt harvesting devices. or ground wells
Seasonality	Perennial	Perennial or seasonal	Mostly seasonal	Perennial only with ground supply
Command area (ha) – Sri Lanka	>600	80-600	<80	<1
Planning and Management	State	State or Community	Community	Community or individual farmers
Construction	Outside contractors	State	Community using local materials.	Community or individual farmers
Limnology	Low natural productivity & CPUE** for stocked species (i.e. which are not self-recruiting)	Higher natural productivity due to vast draw down	Increasing natural productivity. Highest CPUE for stocked species.	Easily managed by farmer interventions

* 1= Small-scale: household or community managed.

2 = Large-scale: formally managed by an institution outside the local community.

** Catch per Unit Effort.

Irrigation systems are comprised of the following functional subsections: water collection, water delivery, on-farm application and waste water removal. Potential exists to incorporate aquatic production in each of these components. Although small-scale water storage has been practiced for thousands of years, attempts to integrate fish production into these systems are few, concentrated mainly over recent decades (Haylor, 1994) and restricted to conventional capture fisheries approaches.

Integration of fish production into these agricultural systems is compatible with the following needs of resource poor farmers in marginal areas:

- *Food security*: Production of a cheap high quality source of protein (in many semi-arid areas protein intake is insufficient to meet minimum FAO/WHO recommended safe standards)
- *Livelihood diversification* through aquatic production as an income generating activity.
- *Infrastructural maintenance*: Potential use of fish production derived revenue for improved maintenance of communally managed irrigation structures, with indirect benefits to agricultural production.
- *Improved efficiency of water use*. Aquaculture can be a low on non- consumptive use of water thus it's integration within irrigation systems offers a means of increasing the productivity of scarce water resources in a highly sustainable manner.
- *Social cohesion*: Possible enhancement through community participation in aquaculture activities. Equally, potential for conflict exists where the diverse requirements of different water users and uses are not recognised or where existing social and economic hierarchies are threatened.

2.3 Watershed management:

Box 2: Major issues associated with poor land and water management in the dry zone of Sri Lanka and India (after Gamage 1997, Nigam et al 1998).

- Resettlement of landless farmer in already degraded or degradation prone land.
- Uncontrolled land alienation (in Sri Lanka), legislative support and enforcement, unfavourable tenancy conditions and poor land use planning.
- Encroachment of stream banks, reservoir reservations and catchment areas, coupled with poor land management practices resulting in accelerated soil degradation, loss of reservoir capacity through siltation and agricultural productivity.
- Pollution of fresh water resources following the shift to high input agriculture and increased reliance on agro-chemicals.
- Denial of control of water to local communities.
- Unrestricted access of individual landowner to groundwater under common law resulting in lowering of water tables following increased access to pumping technology.
- Inadequate incentives and resources for soil and water conservation, groundwater recharge, efficient and sustainable use of water resources
- Low agricultural productivity and unavailability of marketing facilities for produce.

The causes and impacts of poor land and water management are inextricably linked (see Box 2) and consequently efficient and sustainable land and water management practices go hand in hand. The watershed⁹ is both a natural ecosystem and a logical unit that integrates the socio-economic and biophysical factors that lead to environmental degradation and food insecurity. Community-based water and land management at the watershed level can lead to increased options for on-farm water management at the individual level (Barr 1998, Pretty 1995). The meso-watershed containing a hydrologically connected series of tanks was identified as the fundamental unit of this research for which further biophysical and socio-economic justification, is presented in Working Paper SL1.3. Some of the physical components of watershed management are shown in Table 3.

⁹ Defined as any surface area through which rainfall is collected and drained at a common point, thus forming a single hydrological unit (Myrada and IIRR 1997).

Table 3: Principle components of integrated watershed development programmes (Myrada 1997).

Criteria	Description
In situ and ex-situ moisture conservation	Treatments on arable and non-arable land and drainage lines, including construction of silt and water harvesting structures.
Integrated production systems	Including forestry, agro-forestry, horticulture, aquaculture in stored water etc.
Implementation of sound crop production systems	These should be identified and implemented through the involvement of developmental agencies, i.e. inter cropping, multiple cropping.
Infrastructural sustainability	Developing sustainable infrastructure and people organisations to maintain developed resources.

Watershed development revolving around community institutions is a huge development initiative in Sub-Saharan Africa and other semi-arid areas of the world. The Indian government currently spends some US\$300 million on a variety of watershed development programmes in semi-arid areas (Barr 1998). In the southwestern Indian State of Karnataka, as in the rest of India, watershed management is a relatively new activity, incorporating the construction of large numbers of small community or farmer-managed water bodies for rainfall harvesting, groundwater recharge and the prevention of soil erosion. In Sri Lanka, as in many parts of India, watershed management mainly exists in the form of the ancient community managed cascade tank systems, large-scale rehabilitation of which has take place over recent decades. Traditionally the watersheds of these systems were divided into different sections identified for a specific purpose. People had their houses and home gardens close to the tanks. Land adjoining the village was used for slash and burn (chenna) cultivation, whilst forests in the catchment were left undisturbed (Ulluwishewa 1995).

3 Background to the research areas in Sri Lanka

3.1 Introduction

Sri Lanka (5-9°N; 79-82°E) is a tropical island lying 50km to the South West of Peninsular India. It is relatively small for a continental island, with maximum width and length of 240km and 435km respectively, a coastline of 1760km and an area of 65,525 km², of which some 32,000 km² are under permanent or shifting cultivation (see Table 4). After excluding the plantation sector, over 71% of the remaining cultivable area is rainfed. Though population growth is stabilising (currently growing at 1.1% per annum), with a total of 18.1million persons, population density is high and average land holdings low (80% < 1.2 ha and 40% < 0.4ha, Gamage, 1997). Nearly 80% of the population live in rural areas, of whom over 55% depend on agriculture for their source of primary income. An additional 17% are employed in seasonal labour activities, 80% of which are in the agricultural sector and another 8% recorded as being employed in the fishing industry (Central Bank 1998).

A map of the country showing administrative divisions and the major climatic zones is shown in Figure 1.

Figure 1: Administrative Districts, agro-climatic zones and principle towns in Sri Lanka.

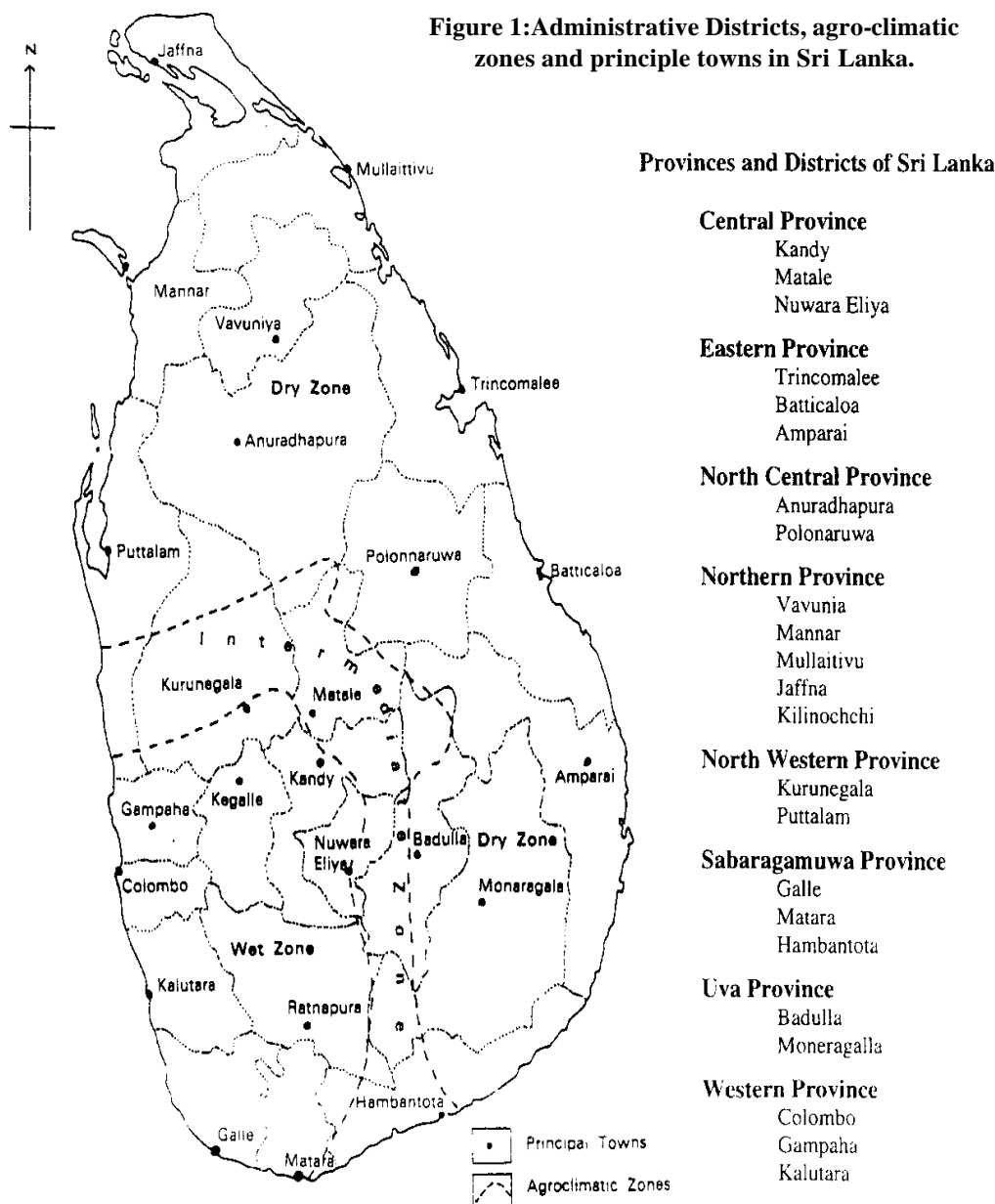

3.2 Irrigation

Sri Lanka has almost no natural lakes, yet it has 3ha of inland water per km² of land (almost 2% of the land surface – De Silva 1988). Most of this vast acreage is a man-made legacy of ancient irrigation systems. The smaller rainfed village tanks have played the greatest role in shaping livelihoods within the lowland dry zone and life in most villages continues to revolve around these systems. An estimated 18,000 tanks are clustered into 3500 to 4000 Small Tank Cascade systems (STCs) with greatest concentrations in the selected project areas of the Northwest and North Central Provinces (DAS 1996). Slightly over half of these tanks are operational¹⁰, of which 80% are 25ha or less at maximal waterspread. All but the smallest effectively private tanks (<5ha) are under state jurisdiction but community managed on a day-to-day basis. Tanks are arranged within cascading sequences of between 2-25 tanks, used to

¹⁰ Supporting an adjacent community.

manage the smaller meso-watersheds that cover much of the lowland area.¹¹ Tanks tend to decrease in size and increase in seasonality with progressive movement towards the top of the watershed (Working Paper SL1.3).

The principle-irrigated crop, paddy is grown on nearly 600,000ha of land. Nearly half of this total is grown under minor and medium irrigation systems (see Table 7) Of the remaining 250,000ha under major irrigation (>600ha) nearly 130,000ha are under the Mahaweli Development scheme (see Appendix 7). Straddling North Central Province is the Mahaweli H irrigation system, part of the Mahaweli development programme initiated in 1975 to relieve population pressure in the West. This is the project area selected for the linked DFID (KAR) large-scale engineering programme. It is hoped this proximity will facilitate investigation of potential synergies between communities managing large and small-scale irrigation systems.

3.3 Agriculture and the economy

Agriculture continues to be the mainstay of the national economy though it's contribution to GDP is in decline as the manufacturing sector expands (its share rising from 14.8% in 1985 to 19.7% in 1994 – Central Bank 1998). Prior to 1977, farmers benefited from assured markets and high production subsidies under a centrally planned economy, which stressed self-sufficiency in food production (Weragoda 1998) but stifled economic growth. These benefits along with protectionist exchange controls and import quota restrictions were gradually abolished during two decades of progressive economic reform, which aimed to encourage greater market orientation and production efficiency amongst producers (Kodithuwaku 1997) and export orientated economic growth (Kelegama 1999). Although this liberalisation process has resulted in a steady rise in GDP¹², growth has occurred mainly in the manufacturing sector, whilst non-plantation agricultural production has stagnated for a number of reasons. Worldwide productivity growth in rice production associated with the green revolution technology has resulted in rice prices being depressed to their lowest ever historic levels over the last two decades (Barker 2000). Competitive production advantage now lies with deltaic states such as Bangladesh and the riparian states associated with the Mekong delta. These states have benefited from better access either to water in elevated ground water tables following the advent of cheap pumping technology since the 1960's or irrigation linked to large rivers. In addition many of these states also benefit from much lower agricultural labour costs than Sri Lanka. Consequently most varieties of Sri Lankan paddy compete poorly in price with imported varieties. This has led to calls from the World Bank and other international lending agencies for Sri Lanka to diversify into the production of more lucrative and less water consumptive cash crops reflecting local competitive production advantage. However farmers continue to eschew such crops in favour of subsistence paddy cultivation. This is due a strong cultural attachment associated with the primacy of rice in the Sri Lankan diet and way of life, it's good storage characteristics compared to the relatively perishable nature of many cash crops and poor access for the majority of poor farmers with small production surpluses to the newly emerging free markets for such perishable products (Sinathamby and Noguchi 1977; Narapalsingam 1999). Frequent policy changes by the Government in response to conflicting external donor pressure and internal political demands have served to compound the problem.

3.4 Human development and poverty in Sri Lanka

Sri Lanka's distinctive pattern of development with its emphasis on human capital has resulted in the establishment of an expanding network of education and health institutions. Spectacular reductions in infant mortality¹³ have been achieved through immunisation programmes and universal access to good quality primary health care whilst life expectancy

¹¹ Most of these watersheds drain into the one hundred and three river basins which radiate from the wet central highland area. Flowing nearly 200km to Trincomalee in the NE, the Mahaweli river is by far the largest and most important of these resources for major irrigation.

¹² Growth in GDP rose to 6.4% in 1997 with exports contributing 31% of the total compared to 14.9% in 1970 (Kelegama 1999).

¹³ 18 mortalities per 1,000 live births (IADP 1997)

averages 72.2 years compared to a mean of 62 years for the least developed countries. At 90% the literacy rate is not far below the level for industrialised countries. For these reasons Sri Lanka has long held middle Human Development status¹⁴ (UNDP 1998) despite a poor record of economic development¹⁵.

Yet these generally favourable indicators hide wide sectoral and regional disparities¹⁶ (see Table 4) and fail to recognise other important indicators of poverty. The core of the absolute poor¹⁷ in Sri Lanka has remained at around 25-30% of the total population since the early 1970's, whilst relative poverty has grown sharply (Sinathamby *et al* 1998, ESCAP 1997). This reflects a failure of all policies, including those implemented under economic reforms to reduce poverty levels. Poverty remains largely a rural phenomenon. It is estimated that nearly half those below the poverty line in Sri Lanka depend on agriculture for livelihood and another 30% on non-agricultural rural activities (Datt, 1977). Rural households tend to have fewer years of schooling, lowest literacy levels, higher dependency ratios, lower rates of participation in the labour force and significantly higher rates of unemployment and malnutrition. Households relying on agriculture as a primary livelihood activity exhibit the highest poverty levels (Sinathamby and Noguchi, 1997) and most disadvantaged of all are low caste groups and farmers settled in rain-fed upper watershed areas (Working Paper SL1.3).

**Table 4: District wise GDP and Development Indices in Sri Lanka
(Source National Human Development Report 1998)**

Dry zone district	GDP (Rs) Per capita 1994	Human Development Index (HDI ¹)	Human Poverty Index (HPI ²)	Gender Development Index (GDI ³)	Gender Empowerment Index GEI ⁴)
Matale	7592 (9)	0.73 (12)	21.5 (9)	0.46 (10)	0.18 (11)
Hambantota	7119 (13)	0.74 (9)	23.3 (11)	0.47 (9)	0.23 (8)
Kurunegala	8905 (7)	0.88 (2)	22.2 (10)	0.48 (7)	0.26 (7)
Puttalam	7314 (11)	0.73 (13)	19.1 (6)	0.36 (17)	0.03 (17)
Anuradhapura	10832 (5)	0.85 (4)	21.3 (8)	0.56 (1)	0.32 (2)
Polonnaruwa	9047 (6)	0.87 (3)	27.7 (15)	0.56 (2)	0.3 (4)
Moneragala	6659 (17)	0.69 (16)	28.7 (16)	0.41 (14)	0.12 (15)
Sri Lanka Total/Average	8411	0.75	23.4	0.465	0.21

¹HDI variables = Life expectancy, adult literacy, primary to tertiary education enrolment, real GDP per capita.

²HPI variables = Mortality before age 40, primary & secondary education enrolment, access to safe drinking water, safe sanitation, child birth outside formal medical institutions, Immunisation of population and pregnant women against infectious diseases, access to electricity.

³GDI = Calculated as for HDI but differentiated by gender.

⁴GEI: variables = parliamentary, managerial, professional representation & proportion of national income earned by females.

A Human Poverty Index (HPI) (UNDP 1998) which considers a wider range of socio-economic indicators (Table 4) reveals a high proportion of households without adequate access to electricity (56%), safe drinking water (28%) and safe sanitation (24%). Networks of roads, electricity, communications, piped water and sewers radiate outwards from the most populous areas in and around Colombo district deteriorating in quality as they do so. Remoter districts with poorest access to such physical infrastructure consequently score the highest HPIs. By contrast HDI achievements are more closely linked to economic productivity and even remote districts, which have benefited from large-scale irrigation and rural development programmes score high on this scale. Notably, Anuradhapura District scores high on HDI but low on HPI for these reasons¹⁸.

¹⁴ Ranked of 91st out of 175 countries (UNDP 1997)

¹⁵ Sri Lanka is ranked nine places below it's international HDI ranking in terms of GDP

¹⁶ In 1997 Western Province alone generated 43% of GDP and accounted for 72% of the total value of manufacturing output.

¹⁷ Households that spend more than 90% of their earnings on food (Sinathamby, 1998).

¹⁸ Almost one third of Anuradhapura district is covered under the Mahaweli H development programme

Gender Development (GDI) and Empowerment (GEI) are two indices, which reflect women's socio-economic status (see Table 4). Women have attained only 69% of the development of men; although moderate this level is relatively high with respect to the 64% average for all developing countries. Highest achievements are in life expectancy and education (literacy and enrolment) and lowest in income earning potential. Affirmative government policies with respect to education have been at the root much of the wider gender achievement. Despite this achievement, the overall level of gender empowerment remains low. Although female participation in the labour-force has increased significantly over recent decades, it is still only 51% of the male level (ESCAP 1998). In the rural sector female labour tends to be concentrated in casual, low-paid, low skill and low-status jobs and a higher proportion of women continue to work as unpaid family workers. Persistent gender stereotyping and the slow pace of transformation of traditional role models for women (UNDP 1998) perpetuate this situation.

All these indices of development fail to include primary indicators of malnutrition, yet high malnutrition levels persist amongst large sections of the rural community. Sri Lanka records the fourth highest rate of underweight births (20%) in the world (UNDP 1977), whilst 36% of pre-school children are stunted (an indicator of chronic malnutrition). These levels are increasing once again, after food based government welfare was recently replaced with income-based relief (UNICEF, 1997; in Gunasekara 1977). De Silva (1991) estimates mean individual daily protein intake is only about 28g compared to a recommended intake of 45g. Chronic malnutrition compromises the mental and physical capabilities of those affected throughout life.

North West Province: Although Kurunegala district performs well in HDI and basic living standards it has high HPI levels and has experienced slow economic growth over recent years. Puttalam performs badly in both HDI and HPI and also scores bottom in gender development and empowerment indices. Physical infrastructure: roads, electricity, sanitation and safe drinking water are especially poor. This is especially true of the dry-zone rural hinterlands to the North of both districts. Neighbouring North Central Province has recorded the greatest economic growth rate in recent years as the Mahaweli Development programme opened up large tracts of cultivable land (see appendix 7).

Appendices 3 and 4 show a selection of poverty indicators for areas at Provincial, District and Divisional levels (see section 3.6). Disparities between the indicators at different levels reflect wide variations in poverty often at the most local scale. These figures also demonstrate that poverty is not a localised phenomenon, instead superimposed on these wider trends, 'pockets of poverty' can be found through out the country.

3.4.1 The ethnic conflict and human development

Sri Lanka is in the 17th year of an ethnic conflict between a secessionist minority Tamil population and the majority nationalist Sinhalese Buddhist population. National development indicators do not take into account the conflict areas to the North and East, where 16% of the population live and from where more than 800,000 people have been displaced over the course of the war, and the socio-economic infrastructure severely disrupted. Both sides in the war have become highly entrenched which is now characterised as a 'proxy' war. That is the reasons for its perpetuation having diverged significantly from those that initiated it with both sides highly polarised along lines of vested political and economic interest. It remains major drain on the country's economy¹⁹ and one of the chief constraints to future development. Consequently the principal focus of many development agencies (including CARE and DFID) has become one of supporting conflict resolution and helping people in affected areas to deal with the impacts of the conflict.

¹⁹ Annual military spending is equivalent to approx. \$30 per head, or nearly 5.5% of average per capita income (\$540 in 1997) Narapalasingam, S. (1999). Economic growth and human development in Sri Lanka. In "The Island", pp. 8, Colombo..

3.5 Government administration in Sri Lanka

Effective management of common or public property resources, including most of the countries large and small-scale irrigation systems, requires the co-operation of a range of primary and secondary stakeholders. An important factor contributing to the persistence of poverty in developing countries are political structures that render poor people powerless (Hasnip 2001). A clear understanding of the roles and capacity of administrative institutions at local, regional and national levels is therefore essential.

3.5.1 The administrative structure

Figure 2 shows the current multi-tier administrative structure. Below the National / Central Government are the Provincial and Local Government tiers.

The thirteenth amendment to the constitution of 1978 was finally enacted in 1987 in order to devolve limited political and administrative powers to eight independently elected Provincial Councils in the framework of a unitary state. Although this pointed to a positive and irreversible trend towards devolution of the polity, in reality, the Concurrent list of functions assigned within the constitution was manipulated by the bureaucracy of Central Government to undermine the devolutionary process.

With limited fund raising powers, legislative autonomy and overlap in many of their functions (resulting in 'turf fighting' with other central Government and District level agencies) the role of the Provincial councils remains unclear and potential impact largely unrealised (Sunday Times Aug 1998). In Kurunegala District the 'Wayamba Development Authority' an additional quasi-autonomous Provincial Authority also shares responsibility for integrated rural development programming and implementation along with the Provincial council.

The eight Provinces are composed of 25 Districts that are the principle administrative units of local government (Fig 1). Local government at the sub-provincial level consists of a three-tier structure of 14 Municipal Councils, 37 Urban Councils and 258 Pradeshiya Sabhas serving cities, towns and rural areas respectively. The functionality of this urban - rural distinction is increasingly blurred as Pradeshiya Sabhas come to incorporate pockets of urban development. In terms of financial mobilisation, personnel management and local regulation, Municipal Councils tend to exercise the greatest autonomy, whilst Pradeshiya Sabhas are effectively in the permanent sway of provincial and central government officialdom. Furthermore the frequent intervention of central and provincial agencies in the delivery of the same category of public goods and services²⁰ further undermines the consolidation of functions and powers at Pradeshiya Sabha level.

Most ministries have district-level offices, which constitute the middle and lower tiers of the centralised multilateral structure. The GA, the Assistant GA at the Divisional Secretariat level²¹ and the Grama Sevaka Niladhari²² at village level provide the backbone of the district administration. Also present at GN (village) level are the Samurdhi Niyamaka²³ (2-3 per GN division), extension staff responsible for implementing the governments social welfare programme. Although typically elected on political patronage these welfare officers are typically recruited from within their own communities and thus remain incentivised to provide a good service. They represented key collaborators and village entry points within this research programme. Divisional secretariats within Kurunegala and Puttalam, Districts (the areas selected for in-depth study) are shown in Appendix 6.

²⁰ Functions include; Road maintenance & construction, lighting, town planning, public health promotion & welfare clinics, burials, water supply, establishing & maintaining markets, licensing, weights and measures and admin of the food and drugs act.

²¹ There exist approximately 60 to 150 Divisions within each District, each containing 30-40 Grama Niladhari Divisions, which in turn typically contain 4-8 villages.

²² Village level administrative officer.

²³ The lowest tier of the Ministry of Rural Development, Samurdhi (welfare) and Sports.

Figure 2: Structure of the Sri Lankan Governmental Administration (Kurunegala Provincial Council, Gunewardena (Extension consultant Peradeniya University, pers comm).

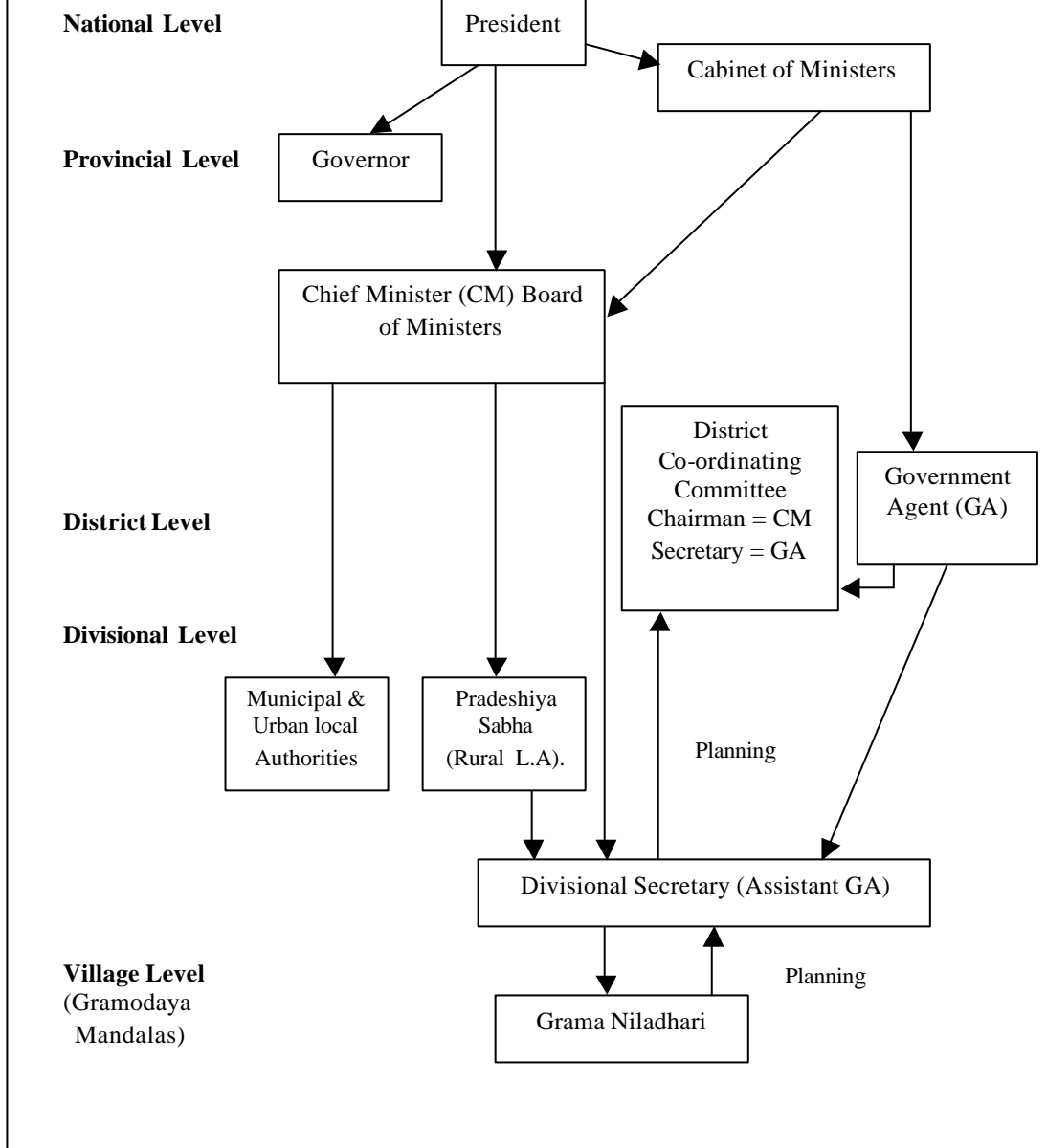

3.5.2 Institutional capacity

Sri Lanka achieved its independence in 1948 after over 150 years of British rule through a process of peaceful constitutional evolution resulting in the adoption of a Parliamentary Democratic System. However, although the country has enjoyed a universal franchise since 1931 an objective assessment indicates that a functioning democracy has failed to emerge with the years since independence, which are characterised by an increasing trend towards centralised governance. In 1978 this culminated in the introduction of an executive presidency and a concurrent drastic reduction in powers held by parliament.

Over the post-independence decades, numerous centralized political and administrative institutions were created with, with ideological dedication to manage the delivery of public

goods and services. However unresponsive to change, many of these institutions have effectively collapsed under the weight and evolving demands of a growing and literate citizenry with good awareness of comparative developments in the contemporary world. Health care, education and skills training, two sectors instrumental in elevating Sri Lanka's human development status in the past (UNDP 1998), today have reached near anarchy (Wanasinghe, 1999). Simultaneously, the growth of the centralized state has shriveled traditional community based institutions (Working Paper SL1.3) and impeded the emergence of new institutions (both NGO and within the polity). Strong political will, combined with public pressure is required to redress this situation. Yet elections though regular, have come to take the form of periodic rituals in between which the public fails to take any real interest in government or its impact on their daily lives, voting rather according to communalistic and patronage criteria. Meanwhile the vested interests of centralized elites generated within this *status quo*, remain a formidable obstacle to real change. Growing negativism and alienation of the public towards the processes of governance have contributed to recurrent violent civil wars (the last 1989-91 was super-imposed on the longer-running ethnic conflict) with ideologically motivated and disenfranchised youth ranged in a bloody struggle against the institutions of the state.

Following are some of the other key factors inherent in the weak institutional situation which interacting in a sequence of cause and effect:

- *Command and control*: A culture of centralized control dating back to the British era, whereby a system of local administrations regulated by Government Agents' was developed to co-opt local communities into management activities determined by central rather than local agendas i.e. this was an exercise in administrative decentralization rather than local governance. This historical period has provided an *a priori* classification of the goods and services required by rural and urban populations. This system remains adhered to regardless of the changing, needs, aspirations and spatial spread of the populace entrenched within a caste-like tiered hierarchy of public institutions.
- *Patron client relationships*: Centralization has resulted in decision-making more often being centered on bureaucratic and technocratic factors rather than local needs. This along with the persistence of the 'command and control' system outlined above, have fostered a culture whereby political appointees rather than public servants are seen as patrons, whilst citizens are forced into a client role in every aspect of public life. This in turn has created a perpetual attitude of dependence on the state for maintenance and operation of infrastructure with a concomitant loss of any community sense of ownership (this is particularly evident with respect to irrigation infrastructure - Working Paper SL1.3). Finally within a parody of democracy, this dynamic has given rise to today's culture of 'political *quid pro quo* patronage networks' at all levels of government bringing with them an insidious increase in corruption that has become and integral part of public life.
- *Micro v Macro level policy*: In a well-ordered devolved political system functioning within a market economy, the following clearly defined functions would be attributed to the three main tiers of government (Fig 2). Ministries at the center would be focused on the task of policy management. Those at the regional level would be concerned with the translation of national policy into programmes of action, whilst seeking participation from the private, NGO and local Government sectors at the third tier to manage their implementation and evaluation. Institutional efficiency in Sri Lanka is seriously compromised by the persistent confusion between these local, regional and national roles in political agendas. Ministers and legislature at the central level are increasingly involved in micro-level implementation issues, public appointments, infrastructure etc that are essential for their re-election under the existing electoral system. This fuels the confusion and engenders a destructive rivalry between center and local institutions. Meanwhile, local government institutions are commonly pre-occupied with national issues to which

they can contribute little at the expense of local issues for which they are elected and supposedly accountable. Institutions at the recently formulated Provincial level remain uncertain as to their role, veering from local to national issues to the neglect of regional issues.

- *Minority aspirations:* The potential of minority groups strong in certain areas (i.e. Tamil and Muslim groups in the North and East) to thwart the strategic initiatives of the majority center has also fueled reluctance to increase the autonomy of local institutions
- *Generic ideologies v needs based approaches:* At the local level political agendas are dominated by 'generic' ideologies, rather than by an aggregation of the felt real concerns of local communities. The preoccupation of the public with entirely local personal issues has also contributed to a poor perception of macro-level policies that are impacting on the country.
- *Civil society:* The dominance of the command and control system is mirrored by the painfully slow emergence of a viable countervailing civil society in the shape of Non Governmental and Community Based Organisations associated with locally defined needs-based issues.
- *Increasing bureaucratization:* Increasing electoral deadlock between the two principal political parties has also lead to a proliferation of ministerial portfolios, created as rewards for political patronage, rather than identified needs. With 44 ministerial positions the country now has nearly twice as many ministers as India! There are currently 7 ministries sharing primary responsibility for management of the countries inland water resource. In addition to the extra cost imposed on the country by these new appointees, overlap between ministerial responsibilities has fostered competition rather than co-operation. This has persistently hindered the effective vertical and horizontal integration between line agencies that is a pre-requisite for successful integrated rural development.

Self-government cannot be expected to be a success unless based on a sound system of local governance with close collaboration between central and local authorities (Wanasinghe, 1999). Consequently the situation in Sri Lanka is inimical to the growth of effective local government, CBOs and NGOs and this is identified as one of the most serious prevailing constraints to sustainable development within the country. Although a move into such politically loaded territory from more traditional distributive rural development patterns is fraught with difficulty, this need has been recognised by development organisations including DFID and CARE and will increasingly shape future programming.

Critical requisites for a functional democracy with effectual institutions are vigilance and enforcement of accountability in public institutions. Given the ground reality of the Sri Lankan situation, the institutionalisation of accountability would be most effectively initiated at the level of the local community, where citizens are most likely to comprehend the micro-issues affecting their everyday lives. Great potential is currently being demonstrated in this respect by the Mazdoor Kisan Sangathan (MKSS) an NGO dedicated to improving the performance of elected Panchayat officers (the village level administration closest to the people) in Gujarat State, India. This is achieved through a combination of lobbying for improved access to local government data in participation with community groups and stimulation of rights-based awareness raising at grass-roots level (The Economist, 2001).

The Institutional capacity of fisheries and water management institutions (within the polity, NGO and private sectors) are explored in Working Papers SL1.2 and SL1.3 respectively.

3.6 Physical and climatic Characteristics of the Study area

3.6.1 Agro-Ecology

An agro-ecological region consists of a particular combination of natural assets: climate, soil and relief, which give rise to particular farming systems (Panabokke 1998). Elevation and its effects on temperature and rainfall is the single most important determinant of agro-ecology in Sri Lanka. The surface configuration comprises a south central highland massif rising to 2554m, surrounded by a zone of upland ridges and valleys at a lower elevation. This in turn is surrounded an extensive area of flat lowlands. Three climatic zones, the Wet, Intermediate and Dry zone are defined by this topography. The Lowland Dry Zone (LDZ), which is the wider focus area of this project lies entirely below 300m and covers some 70% of the land area. Within these zones, twenty-four agro-ecological regions (AERs) have been characterised on the basis of 75% probability of monthly rainfall, elevation, topography and soils. Five of these regions are located in the dry zone, the main characteristics of which are shown in Table 5 and their location in Figure 3.

Covering nearly 50% of total area, the DL1 region is the most extensive AER in he country. In terms of its combination of dominant soil types and climate it is representative of much wider arid and semi-arid areas in tropical and sub-tropical regions. This wider agro-ecological recommendation domain, the relative poverty of the area and its hydrological endowment lead to selection of the DL1 AER as the primary area for field research.

Table 5: Distinguishing characteristics of Agro-Ecological regions of the dry zone (after Panabokke 1998)

Agro-Ecological Region	Annual Rainfall (mm) ¹	Terrain	Soils
Dry Low Country 1 (DL 1)	>775mm	Undulating	RBE ² and Low Humic Gley
Dry Low Country 2 (DL 1)	>900mm	Undulating and flat	Non-calcic brown, RBE, alluvium, Solidized Solonetz, Regosols
Dry Low Country 3 (DL3)	>575mm	Flat to slightly undulating	Red yellow latosols and regosols
Dry Low Country 4 (DL4)	>575mm	Flat	Solidized Solonetz, Solonchake and Grumusols
Dry Low Country 5 (DL 5)	>500	Undulating and flat	RBE and Solidized Solonetz,

¹ At the 75% expectancy level. ² Reddish Brown Earth

Figure 3: Map showing agro-ecological regions of Sri Lanka.

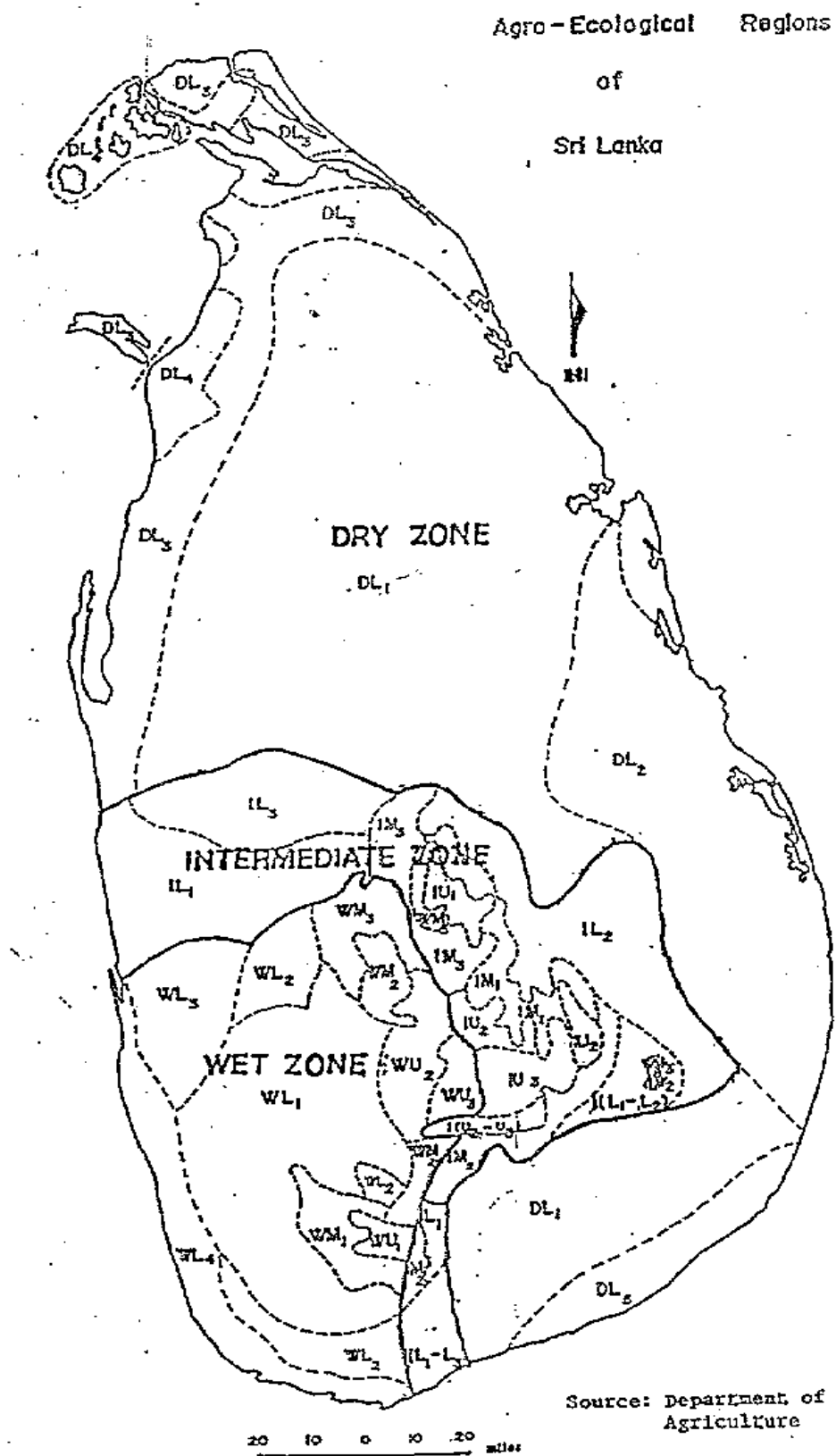

3.6.2 Soils and Agricultural Land Use

Soil characteristics have a major impact on agro-ecology through their effect on water storage and cropping patterns. Climate (rainfall), parent material and topography are the most important soil forming factors. Although Fourteen Major Soil Groups have been described in Sri Lanka (Panabokke 1998) as in other extensive areas of the semi-arid tropics, two types; the Reddish Brown Earths (RBEs) and the Black, Low Humic Gleys (LHG²⁴) predominate in the dry-zone. RBEs cover nearly 80% of the dry-zone. Nowhere else in the world are they so distinctively developed. These soils occupy the higher aspects of the undulating landscape and are replaced in lower depositional areas by LHGs. Some important physical characteristics of these soils are shown in Table. 6.

Table 6: Characteristics of Red and Black soils in Sri Lanka (source Panabokke 1998)

	Red Soils (RBE)	Black Soils (LHG)
Depth	Shallow & weathered	Deep, depositional
Clay content	10-20%	30-70%
Water holding capacity	Low (highly porous)	High
Water run-off	Tend to crust with runoff up to 20%	10-40% (depending on slope)
Fertility	Low: Poor in N & P (occasionally Ca & S)	Moderate to High: Poor in N (occasionally Zn)

Black soils are generally more productive than red soils due their greater depth, water holding capacity and fertility. However they are heavy, difficult to work and surface drainage is required in many cases. Where these soils are sufficiently deep and rainfall high, double cropping (i.e. during the major and minor monsoon seasons) may be attempted under rain-fed conditions. This is less feasible in red soil areas though inter-cropping remains a possibility.

Table 7: Land utilisation within agricultural holdings in Sri Lanka (Source: Gamage, 1997, ESCAP 1997).

Type of agricultural land use	Area	
	Total (million ha)	Percentage ¹
Total land area	6.5	
Natural forest cover ²	1.5	
Total area under agricultural production	3.2	100
A. Permanent cultivation	2.07	65.8
• Plantation (tea, rubber, coconut)	0.94	29.4
• Mixed upland crops and home-gardens ³	0.6	18.8
• Total irrigated Land	0.6	18.8
Irrigated paddy under seasonal tanks (<80ha) ³	0.23	7.4
Irrigated paddy under seasonal tanks (80-600ha)	0.05	1.6
Irrigated paddy under major irrigation (>600ha)	0.25 (0.13 ⁴)	7.8 (4.1)
B. Shifting slash and burn ³	0.95 (0.2 ⁵)	29.7 (6.3)
C. Pasture	0.02	0.63
D. Uncultivated cultivable area	0.092	2.9

¹ Expressed as % of total area under agricultural production. ² More than four fifths of this total is located in the dry zone.

³ Principal forms of cultivation practised by farmers in rain-fed areas ⁴ Area under entire Mahaweli Irrigation Scheme.

⁵ Total area annually cultivated under slash and burn cultivation.

Table 7 shows the extent of the principal forms of agricultural land use in Sri Lanka. In the rain fed focus areas of this project, most villagers derive their primary source of household income from farming activities. Paddy (the staple food along with fish) is the principal irrigated crop. Dryland crops are grown under a traditional pattern of shifting 'slash and burn' or fixed highland cultivation, whilst vegetables and other cash crops are also grown in smaller home-gardens. Livestock holdings, already low within this predominantly Buddhist society,

²⁴ In the UNESCO-FAO nomenclature RBEs correspond to Chromic Luvisols and LHGs to Eutric Gleysols.

are declining further due to reduced pasture availability and the mechanisation of tasks formerly undertaken by draught animals (Central Bank 1998 and pers. obs.)

3.6.3 Climate

Rainfall: Although Sri Lanka is classified as having a semi-humid tropical climate; conditions in the dry zone range from semi-humid, semi-arid and arid (Somasiri, 1991). Rainfall ranges from 625-1900 mm p.a. (see Figure 4) unevenly distributed over two growing seasons, with 60-70% falling during the *maha* season (late September to February) and 20-40% falling during the minor *yala* cultivation season (Late February to June– See Table 8 and Figure 7). These seasons are associated with the arrival of the Northwest and the Southwest monsoons respectively. Two drought periods occur during the inter-monsoon periods between February to May and August to October. Rainfall is highly erratic with the co-efficiency of variance for annual rainfall during the last 15 years ranging from 20-33% (Table 8). Inter-annual variability has been shown to be greatest during the *maha* season (Yoshino et al 1985) and severe drought events associated with the failure of the NW monsoon re-occur on average every 3-4 years in the dry zone. Three consecutive drought years were experienced from 1981 to 83 and again in 1991 and 1996. Whilst inter-annual variation in rainfall has increased over the last 30 years (Yoshino et al) absolute rainfall levels have decreased as shown in Figure 6. Abeywickrema *et al* (1991) report the decline to be as high as 25% over the last century. The increasingly erratic nature of rainfall patterns has been accompanied by an increase in the frequency of flood events, with disastrous consequences for agriculture and physical infrastructure.

Temperatures and evaporative conditions within the dry zone are uniformly high (see Figure 7). The seasonal pattern is also bimodal with a mean annual temperature of 28°C and a mean daily range of 9°C. Relative humidity averages 60-65% by day. Maximum and minimum temperatures rarely drop below 20°C or above 36°C. Winds and rains associated with the two monsoons are the main modifying influence. During May to September warm drying westerly winds known as the *karachan* blow over the central dry zone, increasing evaporation levels and narrowing the daily temperature range to about 6°C. These winds disrupt the reservoir gill-net capture fishery, contributing to a low production season between May to July.

District-wise climatic variation: Table 8 shows summary climatic statistics, and Figures 5 to 7 (annual and monthly rainfall / temperature) patterns. Data was collected from five meteorological stations at locations spread across the research area within the DL1 AER (see Figure 11). Summary statistics show a progressive decrease in the quantity and reliability of rainfall (as measured by the co-efficient of variance) with movement North (and receding influence of the hill country). Polpitiyagama DS, which is located in hilly country close to the boundary of the Intermediate zone records the highest and most reliable rainfall characteristics, conversely Galgamuwa and Kahatagasdigiliya, the Divisions furthest North record the lowest and least reliable rainfall. These trends are also reflected in the water balance deficits²⁵ indicated for the three relevant districts (Figure 8)²⁶.

Water balance: Low rainfall coupled with high potential-evapotranspiration (PET) rates in the dry zone (averaging 2,100 mm/year - Gamage 1997) result in negative annual water balances occurring in all dry zone districts (see Figure 8). Consequently, farmers experience water deficits for much of the year limiting the rain-fed growing period to less than 150 days per year and extensive habitation is only possible where water is stored for irrigation. Livelihoods are dominated by small-scale crop production, subject to marked seasonalities in food availability, prices, income and employment opportunities, credit requirements and health

²⁵ A net statistic combining rainfall levels with evapotranspiration rates.

²⁶ Note: Water balance levels for Puttalam and Kurunegala are positively skewed as much of their territory (out - with the research area) lies in the Intermediate Zone.

(through water borne diseases and seasonal food deficits). Overlap of these factors results in periods of greatest vulnerability occurring from July to September.

Table 8: Summary climatic statistics for divisional secretariats in Puttalam, Kurunegala and Anuradhapura Districts 1985-1998

Divisional Secretariat	Polpitiyagama	Anamaduwa	Galgamuwa	Kahatagasdigiliya
District	Kurunegala	Puttalam	Kurunegala	Anuradhapura
Mean annual rainfall (mm)1998	1596	1152	1037	1226
Mean annual rainfall(mm)1985-98	1628	1153	1012	1126
Standard deviation (mm)	330	287	325	437
Co-efficient of variance (%) ¹	20.2	25	32	33
Yala ² % Total Rainfall	27.9	28.2	25	22.1
Maha ³ % Total Rainfall	61.3	60.4	66	68.4
Dry months % Rainfall	10.8	11.5	8.8	9.5

Notes:

¹A measure of variability = Standard deviation (s) divided by the mean multiplied by 100.

²The minor cultivation season (April to June).

³The major cultivation season (September to February).

Sources:

Grama Niladhari Divisional Planning offices, Agrarian Service Departments, GoSL Meteorological office.

Figure 4: Map showing annual rainfall distribution in Sri Lanka (Source: Dept of agriculture 1996).

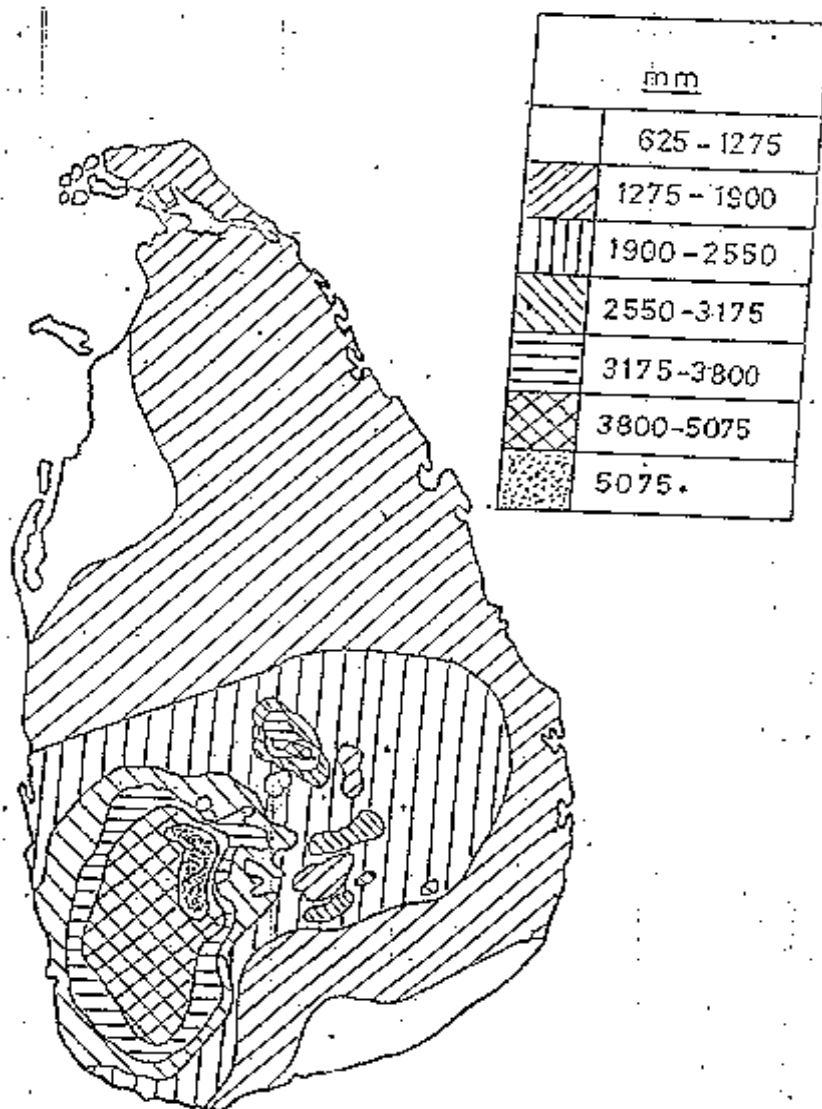

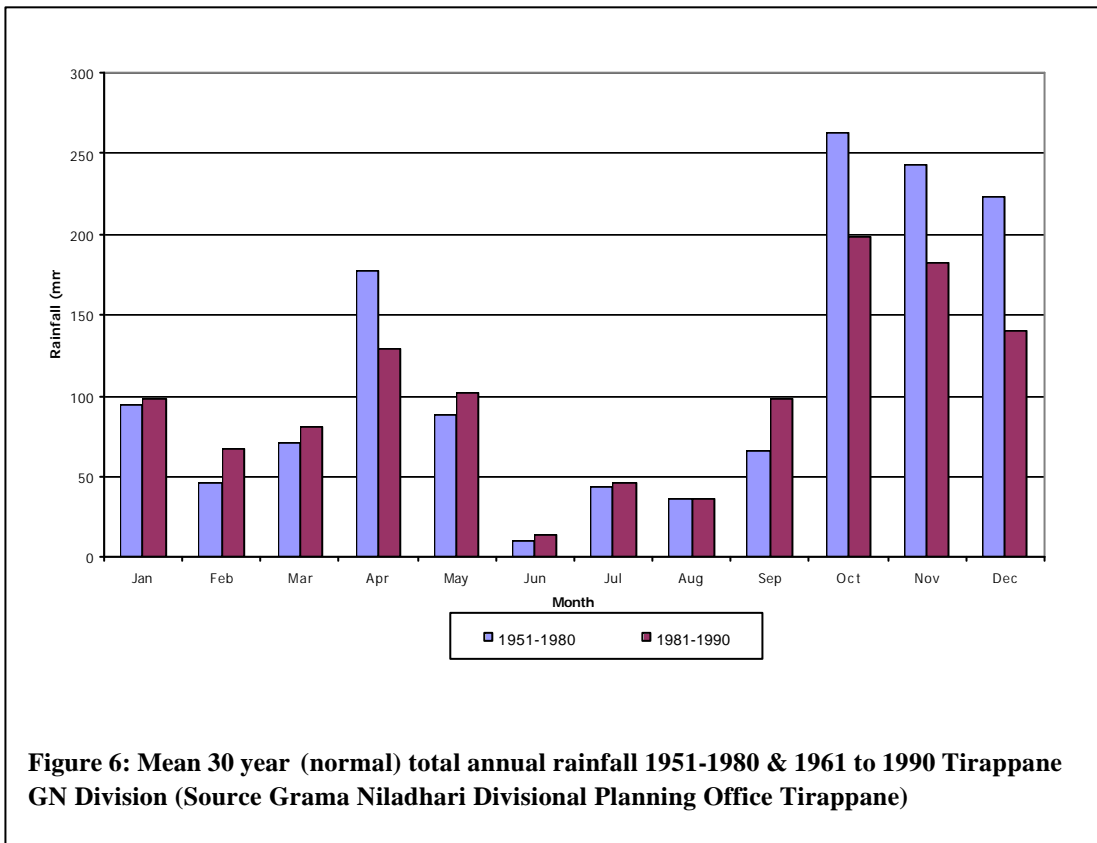
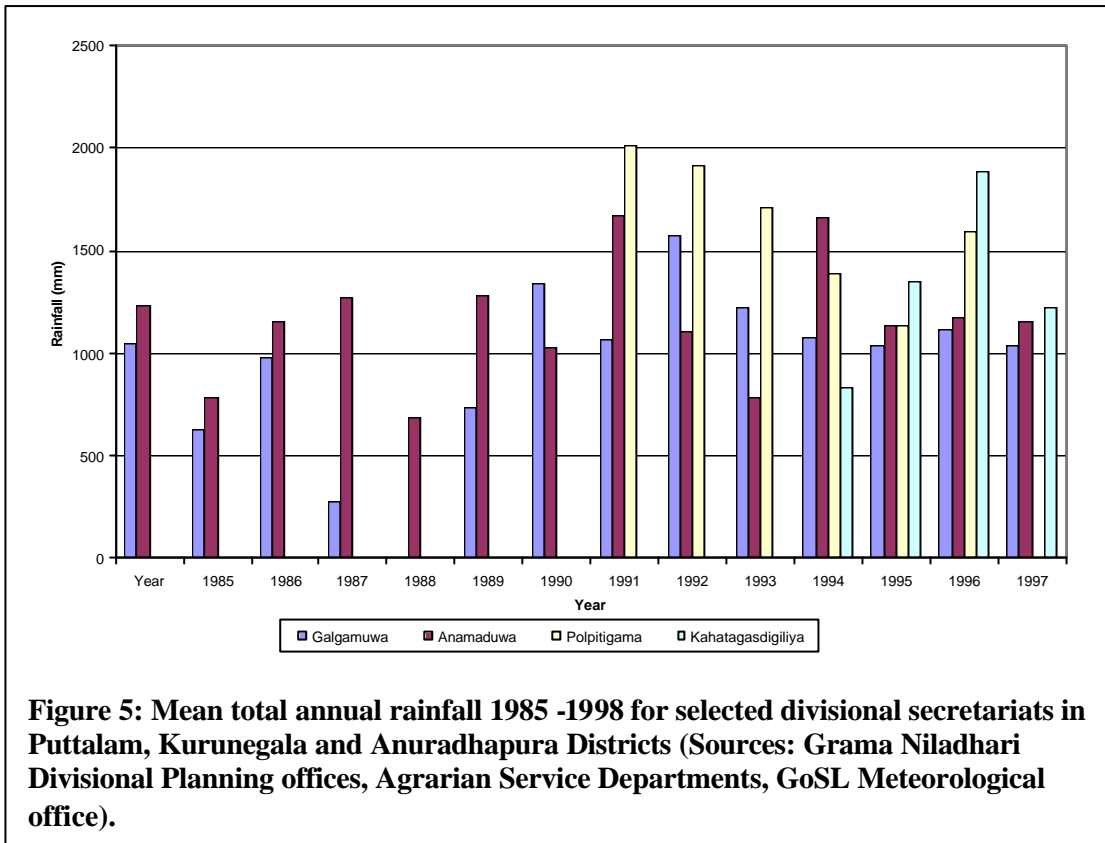

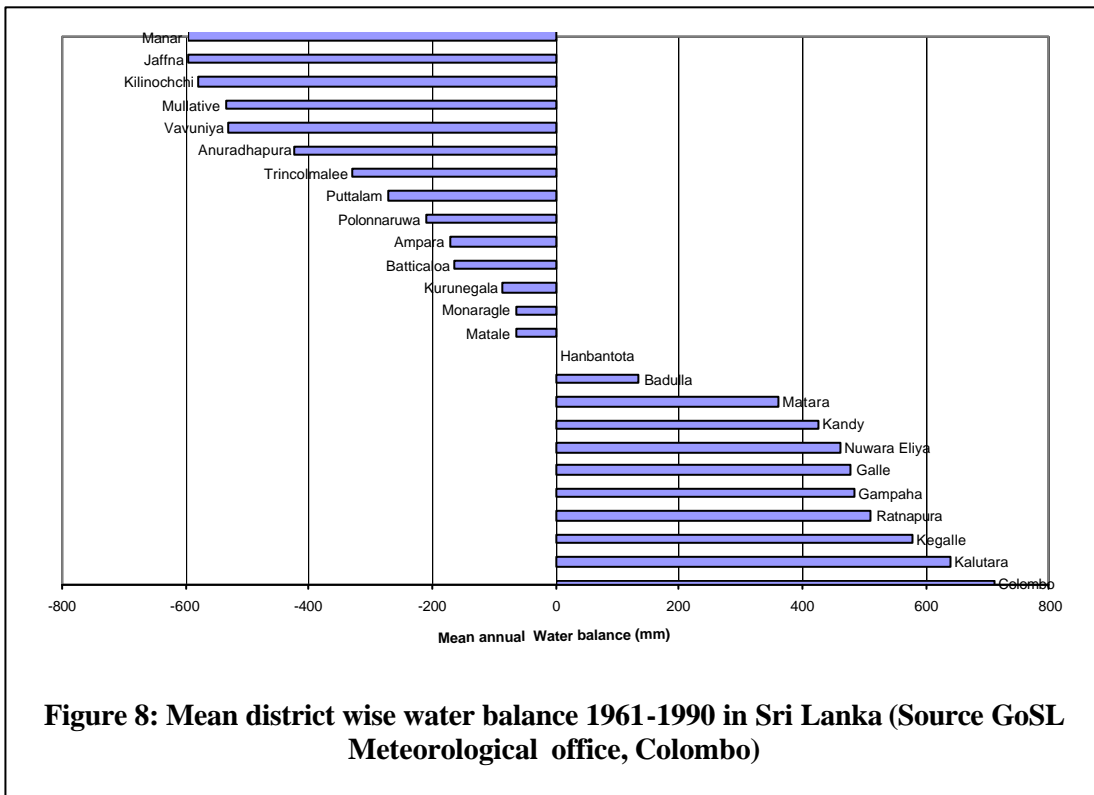
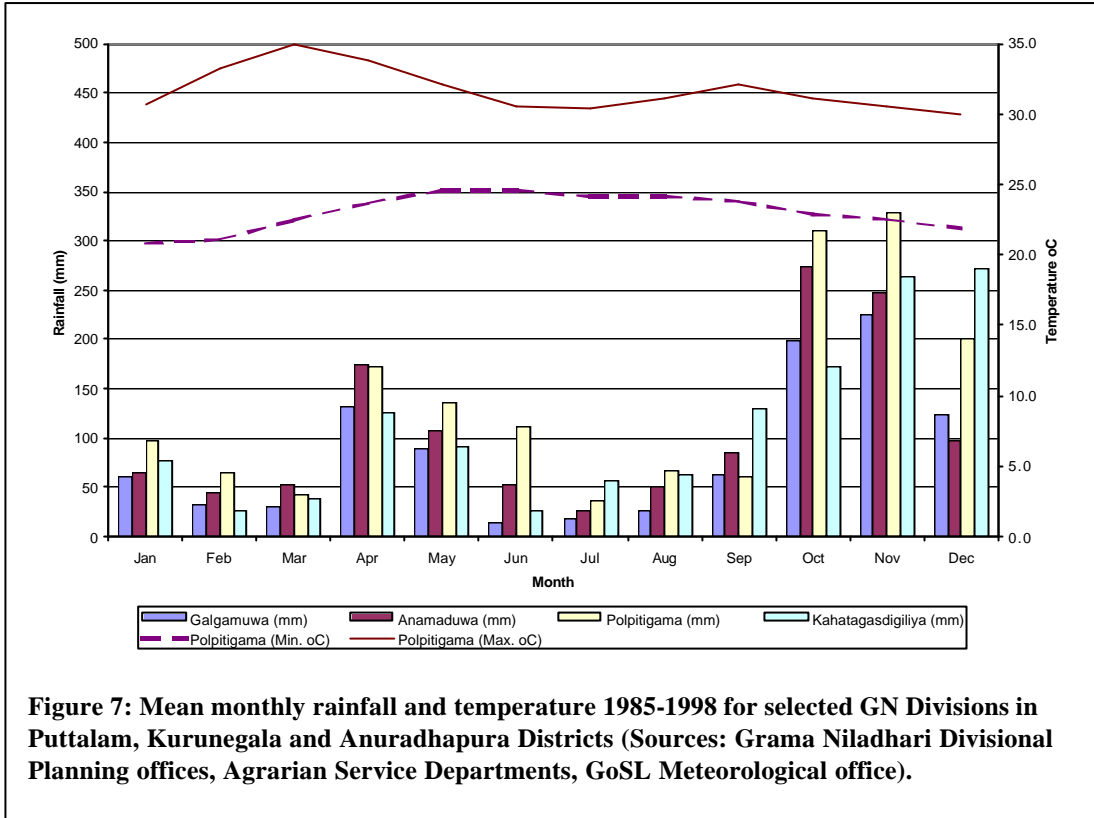

4 Methodology

4.1 Participatory methods:

The broad aim of participation is to enhance the likelihood of achieving sustainable development by increasing the involvement of socially and economically marginalised people in the decision making over their own lives (Guijit and Shah 1998). The participatory approach is the consequence of an evolution in development paradigms over recent decades. This change has been fueled by the unsustainable outcomes of many conventional development programmes. These generally 'top-down' approaches often determine the scope, content and expected outcome of a project even before fieldwork commences. By contrast participatory approaches encourage all those with an interest (stakeholders) to play an active role in defining their own needs, decision making and carrying out subsequent activities. The approach has been identified as especially suitable to meeting the needs of farmers in diverse, risk prone environments (Chambers, 1983).

It is important to distinguish the role of participatory research (the role of this project) and participatory development. Participatory research involves the systematic collection and analysis of data in order to increase the sum of knowledge. In the context of the research funded by development agencies such as DFID (White Paper 1997) there is an explicit requirement for research outputs to result in direct economic benefits to end-users (i.e. development impacts), specifically poorer sectors of the community. However, the closeness of the link between participatory research and development means that the generation and application of knowledge will often be inseparable (Haylor 1999). Scoones and Thompson (1994) identify three key areas which give insights into the role of research in participatory compared to conventional development approaches. These are summarised in Box 3.

Box 3: The role of research in the participatory paradigm (after Scoones and Thompson 1998).

1. **Changing Roles:** The perceived roles of different actors have changed dramatically from those adopted in the earlier paradigm of technology transfer (which continues to be widely practiced).
 - Farmers from recipients to: observers, analysts, experimenters, monitors and evaluators (i.e. active stakeholders in all parts of the development process).
 - Extension workers from conveyors to: convenors, facilitators, catalysts and consultants.
 - Formal researchers from definers of problems and solutions to: recipient, facilitator, consultant and co-researcher.
2. **Knowledge and power:** Some types of knowledge, particularly modern science, tend to monopolise research agendas at the expense of indigenous knowledge systems. As scientific establishments tend to link most easily with village elites there is a need to:
 - Act on the knowledge and needs of diverse groups varying in gender, age, socio-economic status and capability.
 - To find ways in which marginal groups can enhance their own knowledge and influence the research agendas of outside support agencies.
3. **Organisational Culture:** Organisations with top-down hierarchies and supply driven agendas often hinder rather than facilitate development. Change to demand driven agendas based on bottom up determination of needs with lateral sharing, may involve the formation of collegiate networks and interactive learning and research environments to enhance scaling up and dissemination.

A wide variety of tools have been developed for use in participatory fieldwork, details of the main tools employed in this project are listed in Box 4. These are employed systematically in what are known as Participatory Rural Appraisals (PRA's) and Rapid Rural Appraisal (RRA's), the major distinction lying with the degree of farmer participation. In Rapid Rural Appraisals data collected by both farmers and researchers is analysed by researchers and findings and recommendation presented back to the community. In PRA's (which involve

lengthier and more costly fieldwork periods) farmers also take part in the analysis of data facilitated by researchers. These techniques may be combined with questionnaires and survey techniques conventionally used in preliminary appraisals, relative to the needs and resources available to a specific project.

Use of PRA's and RRA's enables the quick collection of information on new areas and identification of issues on which there was little prior outside knowledge. It offers scope to explore issues, which emerge as being particularly relevant and to pay particular attention to avoiding certain biases (Box 5). The process helps farmers and researchers to quantify and analyse the use of resources in farm households and assist in the identification of researchable constraints and opportunities. In addition researchers can discuss with farmers the likely resource use implications at the farm level of implementing possible solutions and thus improve the impact of the research. This process facilitates the design and evaluation of experiments with farmers, which will constitute the next phase of research.

Box 4: PRA Tools used in the project field research (after Townsley, 1996)

Secondary data sources: Used as in conventional research

Semi-Structured Interviews:

Instead of a formal questionnaire, interviewers use an open-ended checklist of questions related to each topic of interest. This is a flexible method allowing for follow up of interesting topics arising during interview. Interviews can be conducted with *key informants* (people with specialist knowledge about a topic or third parties), with *individuals* or *groups*.

Ranking and Scoring:

Issues or items are placed in order of importance (ranking) or allocated a proportion of a limited number of points (scoring). Used to identify the priorities of a community, or differences within the community when carried out with individuals.

Wealth Ranking: Used to investigate local perceptions of wealth groupings within the community.

Parameters used in the classification identified by villagers, thus revealing local indicators and criteria of wealth.

Diagrams and maps: Used to simplify and present complex information in an easy to understand format. Often used to stimulate the interest of villagers and increase their participation.

Resource flow diagrams: To show the flow of resources (e.g. water, crops, animals, plant/ animal residues, agro-chemicals, money) between the different components of a system.

Watershed maps: To show the ownership of land holdings and waterbodies within a watershed.

Seasonal diagrams: To show patterns of rainfall, food availability, workload, credit etc over a year.

Venn diagrams: To show the relationships and connections between different individuals and institutions in a community.

Social maps: To show distribution of all village households along with demographic and resource ownership details (i.e. gender balance, caste, wealth status, literacy, land ownership etc).

Activity charts: To chart the activities carried out by individuals or groups within a fixed time period.

4.1.1 Data validity

Participatory methods have been criticised as being over reliant on qualitative results that are haphazard and over subjective, data summary often being no more than a discussion of the assembled data (Felsing, 1998). To improve the validity of data collected in this study and avoid common biases encountered in participatory research, the rigorous data collection principles outlined in Box 5 were adhered to. However, to improve further the scientific rigour of participatory research, there is further requirement for the development of more quantifiable data collection methods and simple statistical techniques to analyse this data. Such methods should not compromise the ability to provide swift community feedback. Martin and Sherringham (1996) recommend that the relevance of existing statistical techniques be evaluated for different participatory research situations and in particular for the analysis of ranked observations and hierarchical data. Simple non-parametric methods were used to analyse the results of ranking and scoring exercises in this study.

**Box 5: Bias and means of data validation in participatory research
(after Chambers 1983, Yin 1984, Lawrence 1999, Denzin 1970).**

1. **Bias:** The following types of bias in participatory research are identified by Chambers (1983):

- Spatial; (Urban, tarmac and roadside)
- Project; (focus on atypical sites for essentially logistical reasons)
- Person; (Often male village elites)
- Dry season; (field work during wet seasons is often avoided in tropical climates).
- Diplomatic; (politeness and prudence often inhibit contact with the poorest)
- Professional; (lack of interdisciplinary expertise makes it difficult to understand the linkages of deprivation).

2. **Principles adopted to ensure data validity:** Because of the essentially qualitative nature of PRA, non-statistical methods must be used to ensure the trustworthiness of results and to help overcome biases. To this end the following principles of data collection were adopted.

Construct validity: establishing correct operational measures for the concepts being studied; to fulfil this criterion we need to be sure that measures of change do reflect that change.

Construct validity can be enhanced by:

- Using multiple sources of evidence (referred to as *triangulation* by PRA practitioners see notes below);
- Establishing a chain of evidence, in other words providing sufficient information to allow the reader to follow the linkages from cause to effect;
- Iteration (reviewing the output with key informants, and communities in validation feedback meetings).

Internal validity (for explanatory studies only): establishing a causal relationship, whereby certain conditions are shown to lead to other conditions.

External validity: establishing the domain to which a study's findings can be generalised; external validity is enhanced by

- Generalising to a theory, not to a description;
- Using multiple case studies.

Reliability: demonstrating that the operations of a study - such as the data collection procedures - can be repeated, with the same results; reliability is enhanced by

- Documenting the procedures followed;
- Establishing a case study database so that the data can be accessed and re-interpreted by others.

Relevance: Associated with respectful attitudes of researchers and the commitment to bringing about change for development, but may lead to results being less generalisable. In this context there are two principles, which help us to improve relevance:

- Optimal ignorance
- Appropriate imprecision (e.g. wealth ranking instead of income)

Triangulation: these are amongst the most important methods for ensuring data validity:

- Multiple investigators (Repeated examination of a situation by multiple researchers)
- Multiple methods (Repeated use of a single method or use of multiple methods to investigate a specific situation).
- Multiple Data sources (including: i. Temporal triangulation using longitudinal and cross-sectional designs, ii. Space triangulation using comparative research (including separate secondary data sources), iii. Person triangulation, i.e. comparison of responses at different levels, i.e. those at the individual, the interactive level amongst groups or collective level).
- Multiple Perspectives on the same data set (theory triangulation).

4.2 The Research Framework

The research framework adopted for the situation analysis is shown in Figure 9. The process begins with a detailed screening process to determine fieldwork locations, culminating in an RRA of two STC's (RRA rather than PRA was used because of time constraints). The situation analysis also dealt with the national context, including trends in fish production, consumption and marketing, the administrative, political and economic situation.

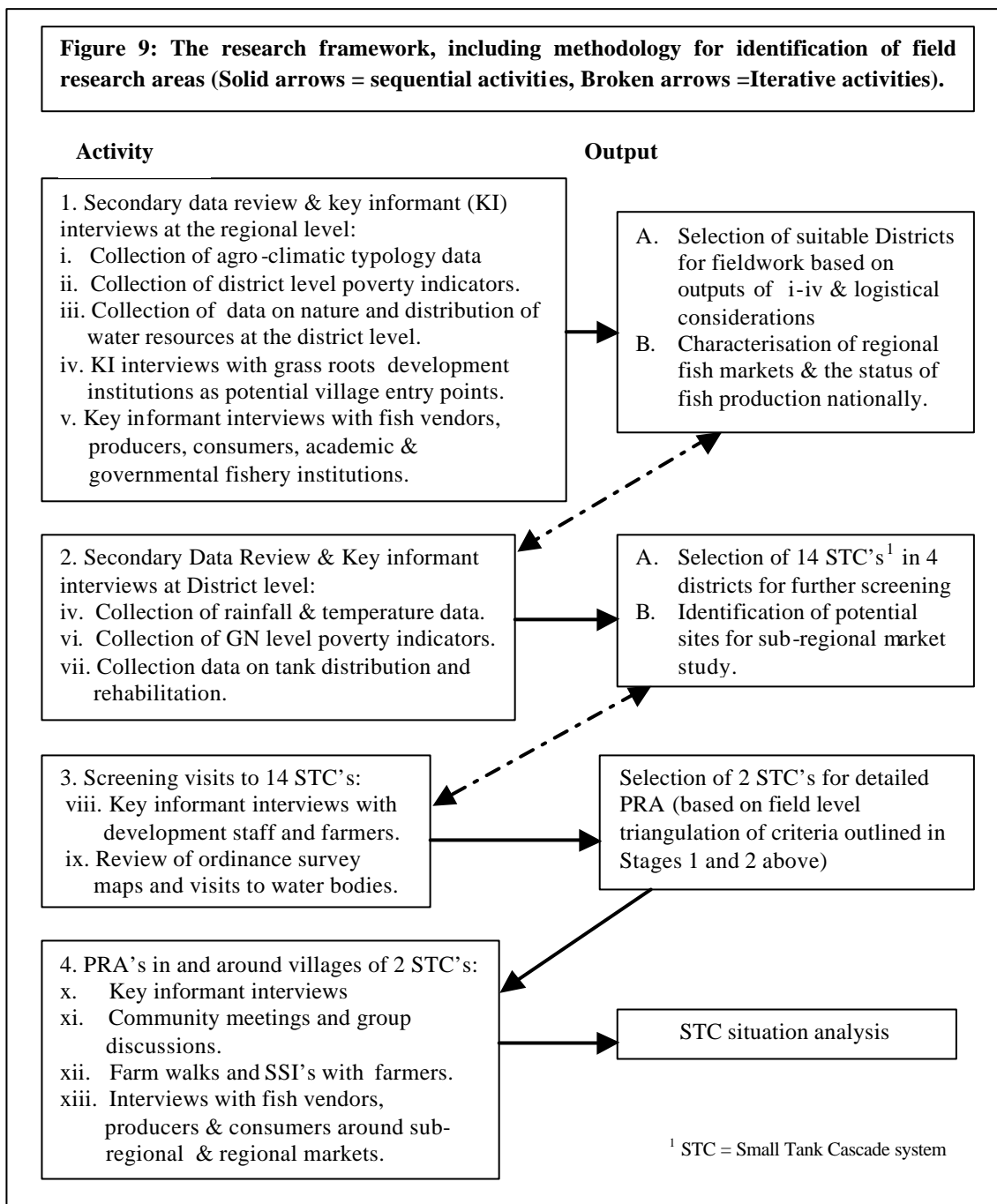

4.3 Determination of field areas for in-depth research:

In a parallel situation analysis in India (Murray and Felsing 1998) collaboration with a grass-roots development organisation determined the regional location of field research sites, in Sri Lanka this became an integral component of the early phases of the situation analysis. Detail of the screening methodology used to resolve from district to the cascade level is shown in Figure 9 the (research framework), Figure 10 (key to locations at the different levels) and Figure 11 (Map showing location of cascade systems screened using field visits).

The DL1 agro-ecological zone was selected as the wider research area because of its extensive coverage of the lowland dry zone in addition to the following characteristics:

- Low and erratic water availability with heavy dependence on traditional rain-fed tank irrigation-based crop production.
- Predominance of small-scale seasonal crop production and marked seasonalities in food availability, income and employment opportunities.
- High levels of rural poverty as evidenced by high and rising levels of chronic protein malnutrition.

Secondary data (from NGO's, Governmental and academic agencies) on water availability (see Working Paper SL1.3) and poverty indicators (see Appendices 3 & 4) were collected at both the regional and district level. These were used to resolve to progressively lower administrative levels and finally the watershed level. Additional selection criteria were based on potential institutional entry points, logistical and safety factors. Districts within conflict zones to the North and East were excluded, as were areas to the South for logistical reasons. Four districts (Puttalam, Kurunegala, Matale and Anuradhapura) within North Central and North Western Provinces were selected for detailed screening at the field level. The Mahaweli H system²⁷, which straddles these districts, is also the focus for linked engineering project on aquaculture in large-scale irrigation systems. This provides excellent opportunities for linking the two projects to produce comprehensive guidelines (to engineers, extension workers and policy makers) for integrating the production of fish and other aquatic animals into irrigation systems.

Within the four districts seven Divisional Secretariats²⁸ were selected for the final phase of screening. Subsequently 14 suitable cascading systems of small seasonal tanks were rapidly screened using site visits, mapping exercises and key informant interviews. Based on poverty criteria and suitable water availability, two of these systems in Puttalam and Kurunegala districts (incorporating a total of 21 tanks and 9 villages) were selected for a detailed participatory livelihood analysis. This also included an assessment of local fish production, marketing systems and consumer preferences. This work was variously undertaken in collaboration with field staff from the NGOs CARE and IFAD and the Government Samurdhi Welfare Programme. Summary results of this situation analysis are presented in Working Papers SL1.2-SL1.4.

²⁷ Straddling North Central Province is the Mahaweli H irrigation system, part of the Mahaweli development programme (initiated in 1975 to relieve population pressure in the West). This is the project area selected for the linked large-scale (KAR) engineering programme. This proximity will facilitate investigation of potential synergies between communities managing large and small-scale irrigation systems.

²⁸ The second lowest administrative tier typically encompassing 90-150 villages.

Figure 10: Flow chart showing resolution from District level to selection of STCs for in-depth study.

Level 1: Province & District

Nothern Province Jaffna & Killinochi Mannar Vavunia	North Central Province Anuradhapura Polonaruwa Uva Province Monoragale	North-Western Province Kurunegala Puttalam	Eastern Province Batticaloa Ampara Trincomalee Mullaitivu	Central Province Matale	Southern Province Hambantota
--	---	---	--	-----------------------------------	--

Level:2 District

Anuradhapura	Puttalam	Kurunegala	Matale
--------------	----------	------------	--------

Level 3. D.S.

Tirappane Kahatagasdigiliya Nochchiyagama	Anamaduwa	Galgamuwa Giribawa Polpitiyagama	Dambulla
---	-----------	--	----------

Level 4. Cascade

Tirappane DS 6. Mahakanamulla 7. Pahala Ambathale Kahatagasdigiliya DS 12. Moraganawella Nochchiyagama DS 13. Dambawelegama	1. Pahala Diulwewa 14. Andarawewa	Galgamuwa DS 2. Danduwellawe 10. Nitalawa 11. Bedigama Giribawa DS 5. Ihala Marankadawela Polpitiyagama DS 8. Mamunugama 9. Amunokole	3. Ethabendawewa 4. Digampatana
--	--------------------------------------	--	------------------------------------

Note: Numbers refer to map locations shown in Figure 11.

Level 5: Cascade level

Pahala Diulwewa	Danduwellawe
-----------------	--------------

Notes on resolution levels.

- **Level 1:** Provinces and Districts located within the dry-zone of Sri Lanka.
- **Level 2:** Selection of 4 districts based on suitable water resource availability, poverty and logistical criteria (including proximity to Linked KAR engineering programme in Mahaweli H system and location out-with primary conflict areas).
- **Level 3.** Selection of 8 Divisional Secretariats (DS) based on poverty criteria and water resources suitable for aquaculture.
- **Level 4:** Selection of 14 Cascade systems for field visits based on (Grama Niladhari (GN) level) poverty data and suitable water availability
- **Level 5:** Selection of 2 cascades for in-depth study based on rapid screening visits made to cascade systems identified in level 4 and presence of suitable institutional entry points.

See project framework (Figure 9) for details of methodology used in selection process and fig 14 for location of STCs screened in level 4 (see also Appendix 5). Appendix 8 shows detail of location of the two sites finally selected for in depth study in Kurunegala and Puttalam Districts.

Figure 11: Map showing location of Small Tank Cascade systems (STCs) screened using field visits (See Figure 10 and Appendices 5 & 6 for key to locations)

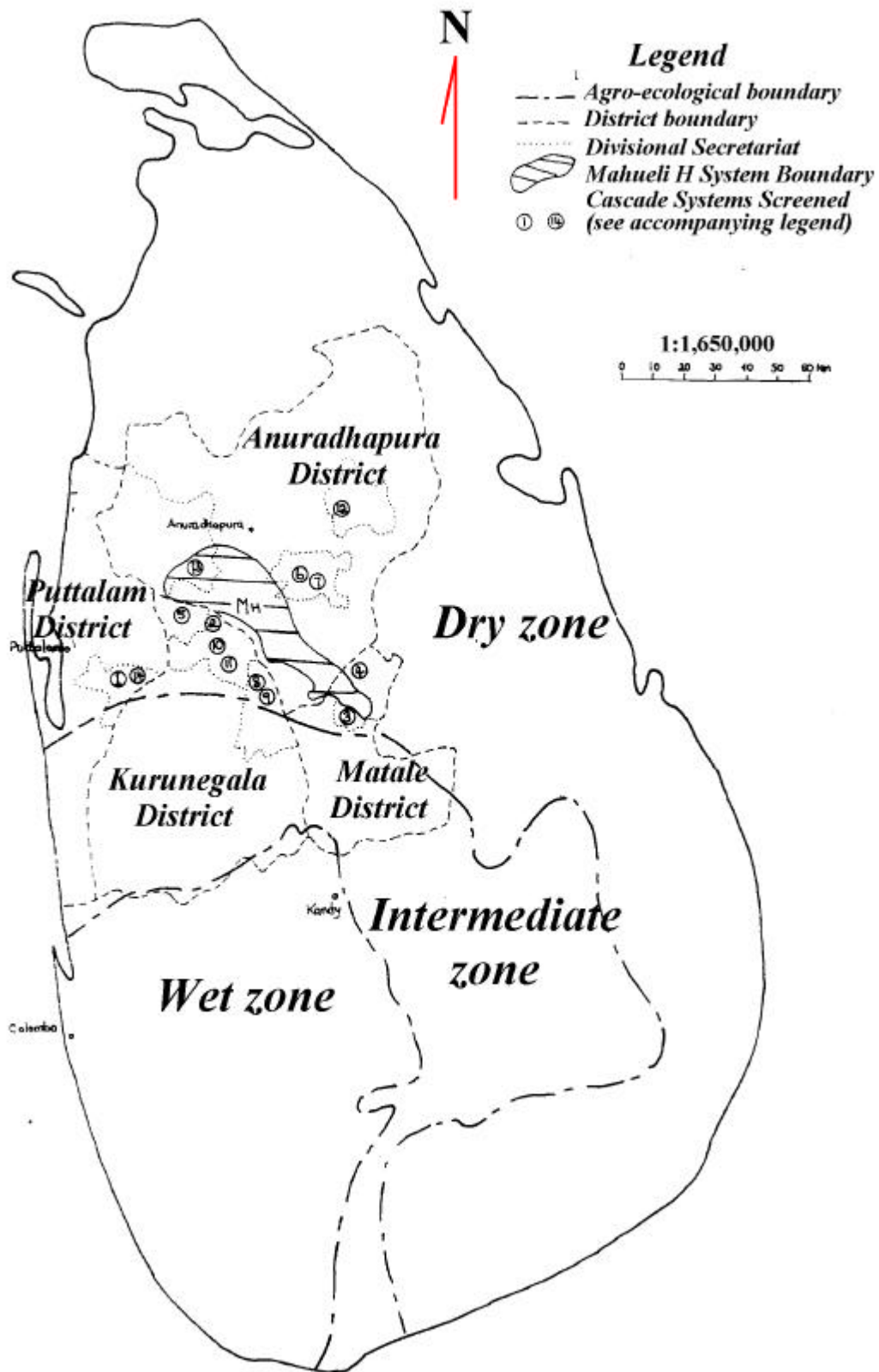

4.3.1 Participatory data collection

Based on the preliminary screening process two of the poorer villages in each cascade (Pahala Diulwewa and Danduwellawe villages both in upper watershed areas) were identified as the sites for detailed RRA's using the range of tools identified in Box 4. These village names were subsequently used to refer to the respective STC systems. Other villages in the cascade system were investigated using key-informant, semi-structured interviews and ranking and scoring methods. Initial introductions into villages were made by staff of the various collaborating development organisations detailed above (in one village the NGO CARE and in the other the Samurdhi welfare extension worker), with the help of whom community meetings were arranged at times suitable for villagers. The function of these meetings was as follows:

- To introduce the purpose and the staff of the research project
- To facilitate group discussions on topics including the village history, cropping systems, indigenous knowledge of aquaculture
- To facilitate mapping exercises, including watershed maps, social maps, institutional vendiagrams, activity charts, time-lines and seasonal calendars. Participants were split into groups of 2-4 for this purpose. In addition to stimulating interest this also ensured participation of as many individuals as possible and productive use of farmers limited time. Such exercises were facilitated by the high literacy rates encountered in most villages.
- To identify criteria to be used for subsequent ranking and scoring exercises with individuals (this ensured that no important criteria were omitted and the same criteria could be used in individual interviews, facilitating statistical analysis.
- Knowledgeable key informants were discreetly identified with whom wealth ranking exercises could be undertaken

Names of participating farmers were collected to assess the attendance of the meetings based on the results of the subsequent wealth ranking. In both instances farmers within the lowest wealth group were poorly represented and tended to participate least in discussion sessions. Consequently additional ranking and scoring criteria were elicited from farmers within this group during subsequent focus group meetings. Whereas in DDW numbers of men and women in attendance were approximately equal, in PWD women outnumbered men by nearly 3 to 1. This was mainly as a consequence of the interest in small income raising activities fostered by the NGO CARE particularly amongst women's groups (also the meeting was viewed as a social occasion by them). Although time and staff limitations meant it was not feasible to have separate male and female meetings, women's participation was facilitated by the presence of gender specialists from CARE and IFAD, and the group activity sessions where women would be split into separate groups.

Wealth ranking was undertaken with at three individuals in each village and the results plotted on social maps. Field observation and further triangulation with development staff were used to resolve discrepancies in the results. The maps thus produced were used as the basis for a stratified random sample of farmers in different wealth groups during the next research phase. This included individual semi-structured interviews, farm walks and ranking and scoring exercises using the previously identified criteria.

Ranking and scoring exercises were undertaken using images representing the different criteria, drawn on separate cards to speed the process. Farmers were asked to lay these out in ranked order of importance and subsequently to score their relative importance (having re-mixed the cards) by dividing a fixed number of improvised counters between the cards. A maximum of 6 criteria per exercise and a total of four counters were allocated per criteria. Tied mid ranks were used where criteria were assigned equal importance. In comparison with the parallel situation analysis in Raichur District India, farmers here grasped this concept

much more readily almost certainly due to their higher education standards. Thus in this situation it was feasible to use both ranking and scoring techniques side-by-side permitting data triangulation. Indeed, introducing the process with the ranking exercise was found to facilitate understanding of the conceptually more difficult scoring technique.

4.3.2 Participatory mapping of watersheds, water availability & quality analysis.

Watershed maps; detailing locations of tanks, command areas and other land uses, and catchment gradients were drawn for each of the cascades visited and used as a basis for the sampling design at the meso-watershed level. Maps were triangulated using the following data sources:

- 1:63360 (1”) and 1:50,000 topographical maps (GOSL).
- Key informant interviews.
- Results of participatory watershed mapping during community meetings.
- Catchment walks.

Seasonal and historic patterns of water availability were investigated using key informant interviews. Farmers were questioned about the frequency of tank spill and drying events, cropping intensities²⁹ over the previous five years. The cascade hydrological endowment³⁰ could then be calculated by comparing ratios of these factors; catchment, command and water spread areas derived from ordinance survey maps.

Water quality parameters of individual water bodies were measured, including pH, temperature, conductivity (measured in-situ using a Hanna HI 9025 metre) and turbidity using a makeshift sechi-disc). Although no longitudinal analysis was possible in the research time frame, it is likely that the worst-case situation for turbidity levels was encountered at the point of investigation (i.e. the onset of major rainy season in December).

Results of this analysis are presented in Working Paper SL1.3.

4.4 Statistical analysis:

Ranking and scoring techniques provide a quantitative means of assessing the priorities of different sectors of the community. They can be used to assess the overall level of agreement between farmers and subsequently the relative importance of different criteria to different interest groups.

Farmers participating in these exercises were asked to adopt a *fixed* scoring regime where a fixed number of points are divided between specified criteria. However, many farmers found it easier to score criteria *individually* out of an identical number of (i.e. 10) points. As this method also proved much speedier than the fixed scoring method and the results are amenable to the same statistical analyses, it was generally applied in future fieldwork.

First the responses of farmers, who showed logical inconsistency between ranking and scoring methods, were rejected. The remaining consistent results were then subjected to the Friedman test, a non-parametric two-way analysis of variance, which can be used to test the null hypothesis that farmer's ranks for each criterion have all been drawn from populations having the same median value. Data (whether from ranks or scores) is ranked and the sum of the ranks is calculated for each parameter. The test statistic is then calculated which determines whether the rank totals for each parameter differ significantly from the values, which would be expected by chance.

²⁹ The ratio of command area harvested to that planted.

³⁰ A summary assessment of water deficit or surplus at the cascade level with respect to primary use for irrigation.

This test has certain advantages over alternative non-parametric tests also identified as suitable for the analysis of ranks and scores (and which share the same null hypothesis). Moods median test cannot incorporate information from related samples i.e. where a single respondent is asked to score the importance of multiple criteria such as alternative water uses. The Kendal coefficient of concordance is linearly related to the Friedman test therefore providing identical conclusions (Siegel & Castellan 1988 in Felsing, 1999). However the Friedman test provides a relatively straight forward computational procedure for a follow up pair-wise comparison allowing the user to identify significant differences between the different ranked criteria.³¹ All three tests are easily carried out in the field with the aid of a calculator. In this study results were analysed using the Minitab statistical analysis package on a portable computer.

Although scoring confers greater information about farmer priorities than ranking (i.e. reflecting the relative rather than just absolute importance), in each of these tests scores must be converted to ranks prior to analysis, resulting in loss of the additional information. Only when scores can be shown to have a normal distribution can they be analysed using parametric tests such as analysis of variance.

4.5 Recommendations for participatory information gathering and analyses.

The following guidelines are presented based on field experience gained during this study.

Community meetings: As an introductory activity community meetings offer scope for the following:

- An opportunity to introduce the research team and its objectives.
- Identifying key informants.
- Identification of criteria for ranking and scoring exercises and wealth ranking exercises.
- Undertaking participatory exercises within focus groups.

Avoiding bias in community meetings: Time and location should be selected to encourage attendance of the greatest number and widest cross-section of the community, including subgroups. Participation of the most marginal groups and reserved individuals should be encouraged by:

- Careful observation and facilitation of field staff.
- Separating woman's and male meetings where possible.
- After introductions, division of the meeting into small activity or focus groups, with frequent feed back sessions
- Criteria for ranking & scoring and wealth ranking should be elicited within focus groups and summarised by facilitators during feedback sessions.
- Results of wealth ranking can be used to construct a stratified random sampling design for subsequent interviews (this ensures equal representation from different wealth groups regardless of attendance at the community meeting).

Ranking and scoring: Criteria elicited at community meetings are subsequently ranked and/or scored with individual villagers. Where the use of both methods proves too time consuming, or tedious for farmers, the results of a single method should be triangulated using a logical line of questioning (i.e. scoring of 'meat preference' criteria could be triangulated with detail of consumption frequencies).

Reject logically inconsistent results based on triangulation and analyse ranks using Friedman's test (see Appendix 9 & 10), using modifications for tied ranks where appropriate. If significant differences are found, the results can be compared using the pair wise

³¹ The primary test statistic indicates only the overall degree of agreement or dissension between all respondents considering all specified criteria.

comparison extension of this test to find between which criteria differences are significant. Where no agreement exists and if the sample size is sufficiently large, results can be subdivided and reassessed according to different sub-groups (i.e. gender, caste and wealth).

To avoid loss of information contained in scored data during statistical analysis, an *individual* rather than *fixed* scoring strategy should be adopted (see statistical analysis). Preliminary assessments also indicate that this is easier for farmers to understand and speedier than fixed scoring. Ranking exercises can be speeded up, by asking farmers to identify the most and least important criteria, removing these cards then repeating the process till no cards remain.

5 Preliminary researchable hypotheses.

The following research hypotheses are based on results of the participatory situation analysis together with knowledge gaps identified from a literature review. Hypotheses are presented after a brief statement of relevant background knowledge.

In Sri Lanka, the following conditions are commonly found around seasonal tanks:

- There is a traditional seasonal subsistence fishery, but no indigenous tradition of aquaculture.
- In the most seasonal tanks regular disruption of natural fish recruitment occurs, necessitating periodic restocking.
- High yields are possible from culture-based enhanced fisheries in seasonal tanks, with no requirement for additional fertilisers or supplementary feeds. Early trials using polycultures of tilapias, and exotic carps yielded 120kg to 2.3t/ha (mean 820kg/ha) in a single growing season (Chakrabarty, 1982). This compares to mean production levels of 256kg in perennial tanks (De Silva, 1991).
- Highly erratic water availability and high predation pressure are attributed as the main causes of the wide yield fluctuations between successive crops, observed in earlier trials.
- Limited technical, extension and private and public seed production capacity in Sri Lanka continues to be major constraints to uptake of culture-based fisheries in seasonal tanks.
- Conventional hatchery based restocking programmes (devolved to community level) continue to be the favoured approach of development institutions in Sri Lanka. Although such programmes can work technically, they have not been shown to be sustainable, and their impacts on poor local people have not been demonstrated.

In this context, greater research emphasis should be placed on low cost enhancement systems, which aim to increase or sustain existing production levels in the face of increasing environmental pressure. Stock enhancement requires a cost-effective means for mass production of young fish. Ideally suited to this role are naturally recruiting and locally available tilapia species. Tilapias have the ability to grow rapidly in short seasonal growing periods and are tolerant of extreme water quality fluctuations common in seasonal tanks.

A simple method of ensuring an adequate seed supply is to stock breeding tilapia and control predation pressure early in the season (e.g. using tanks that dry out and where densities of predatory fish such as snakehead are consequently low). Subsequently, fingerlings of a suitable size can be used to stock less seasonal tanks where predation will be concentrated on their offspring (this will also enhance the by-catch of higher value predatory species, especially the snakehead *Channa striatus*).

Previous studies in Sri Lanka have demonstrated that greater natural productivity is associated with decreasing surface area (Amarasinghe 1998). Thus accelerated growth could be achieved by producing advanced fingerling in the smallest tanks. Communities in the mid to upper watershed may have access to both small and intermediate sized tanks suitable for *in situ* fingerling production and on-growing respectively. The following research hypotheses (which

Figure 12: Envisaged fish movements in a tilapia-based, low-input, enhanced fishery with seed, grow-out and broodstock components demarcated at the watershed level (based on situation analysis in Danduwellawe & Pahala Diulwewa cascade systems of Puttalam & Kurunegala districts, NW Province)

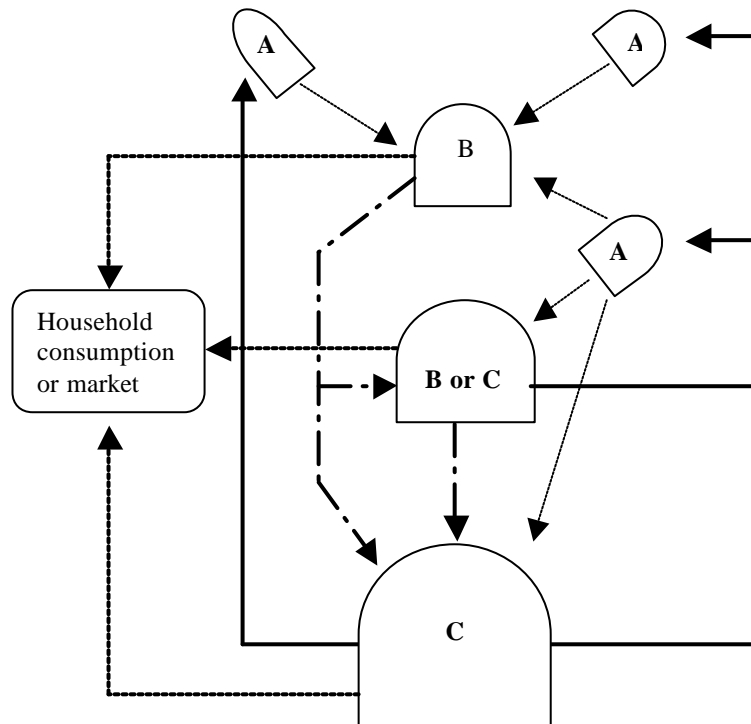

Legend

Symbol	Key
A	Highly seasonal small tank; CPR ¹ or private (Temple/farmer)
B	Semi-Seasonal village tank; CPR
C	Perennial village tanks (rain fed or system ²): CPR
....	Advanced fingerling movements from seasonal tanks
.....▶	Staggered food-fish production (to markets)
- - -▶	Dry season broodstock movements (maintenance)
————▶	Rainy season broodstock movements (in situ fingerling production)

¹ Communal Property Resource.

² Lower tanks may also receive water from medium or major irrigation systems.

Note: The water shed level at which culture components are demarcated will depend on site specific constraints, in particular the seasonal characteristics of the various water bodies accessible to different communities.

should be read with reference to Figure 12) are consistent with these observations³². In the next phase of research hypotheses will be tested through comparison of farmer defined indicators before and after trials, overall farmer satisfaction using in-depth interviews, biological indicators (survival, yield and growth rate) and cost benefit analyses.

(I) Could aquaculture options, which demarcate seed, broodstock and out-growing components, enhance social capital, cohesion and water management at the village and wider watershed level?

³² Hypotheses are prefixed as first (I) or second (II) order hypothesis. First order hypothesis represent the most extensive, simple and lowest risk interventions which should be tested before or independently of second order hypotheses, which seek to further enhance production systems and marketing networks.

- (I) Could advanced fingerlings be grown in small highly seasonal tanks kept free of predators, if mature tilapia broodstock sourced from larger perennial tanks are stocked at the onset of the NW monsoon?
- (I) Could stocking of seasonal tanks with advanced fingerlings overcome the problems of poor survival and erratic water availability experienced in early trials?
- (I) Could broodfish be produced in perennial tanks within the same cascade and what are the most sustainable production systems (e.g. cage culture or simple recapture)?
- (I) Could communities with access to perennial tanks be encouraged to trade broodfish to those with seasonal tanks requiring them early in the season?
- (II) Could the system be enhanced by communities around seasonal tanks selling small food fish to those around perennial tanks for fattening in cages, for subsequent 'buy-back' and use as broodfish?

In addition to seed inputs, low cost fisheries enhancements can incorporate simple habitat modifications to favour the production of useful species. Elevated turbidity levels during the rainy season can impact directly on fish health and reduce primary productivity when it is most critical for fingerling advancement. Turbidity levels are likely to have increased as a result of the widespread encroachment of forested catchment areas for cultivation purposes.

- (I) Could turbidity levels, potential for stock escape, and entry of predators be controlled by constructing low bunds around seasonal tanks to divert runoff waters after the tank has filled to a suitable level?
- (II) Could liming prior to inundation (which accelerates precipitation of suspended material and ensures removal of residual predators) improve productivity?

Production in seasonal tanks is typically concentrated into two months at the end of the dry season (July – August) when supplies from the major reservoir fishery are also at a maximum and prices are at their lowest seasonal level. Poorer farmers are more likely to purchase smaller tilapias (<50g – 200g), being less costly than larger 'table-size' fish. The smallest specimens (<100g) are more likely to be sold as dried fish. Dried fish is relatively more important to the protein intake of poorer groups, but represents a salvage rather than a value addition marketing pathway (Working Paper SL1.4).

- (I) Could staggered harvesting strategies sustain greater yields, higher market prices and hence increase profitability?
- (I) Could staggered harvesting strategies bring indirect benefits to poorer consumers through increased production of smaller, more affordable fish through much of the year?
- (I) Could the production window be widened further if end of season surpluses were dried either for home consumption or marketing when prices have recovered?
- (I) Could the processing and marketing of smaller dried fish (between 50-150g) provide sustainable means of diversifying the livelihood of women's groups?

As most former government hatcheries have switched from food fish to more lucrative ornamental production, ornamental seed availability is good. Small-scale growers are beginning to undertake grow-out production on a contract basis. Such production is easy to initiate and requires relatively low start-up capital, production inputs, or water resources and production can take place throughout the year. Constraints identified by consumers and producers include poor flow of information along marketing channels, lack of species variety, poor quality standards and unreliability in supply (Gunasekera,1998).

- (I) Could the small-scale production of ornamental fish in ponds created on homesteads or cages in village tanks provide sustainable means of diversifying the livelihood of women's or youth groups?
- (II) Could culture of indigenous species improve profitability (through enlargement of species portfolios) and help sustain ecological bio-diversity?

References

- Abeywickrema, B. A., Baldwin, M. A., Jansen, C. M., Bandara, M., and S., W. L. C. A. d., eds. 1991. *Natural resources of Sri Lanka: Conditions and trends*. Natural Resources, Energy and Science Authority of Sri Lanka, Colombo. pp.1-280
- Amarasinghe, U. 1998. *How effective are the stocking strategies for the management of reservoir fisheries in Sri Lanka*. In "Stocking strategies for inland fisheries" (I. Cowx, ed.). Blackwell.
- Barker, R. 2000 *The Asian rice economy in transition. Invited presentation*. Twelfth annual congress of the Post Graduate Institute of Agriculture, Peradeniya University of Peradeniya. 21pp.
- Barr, J.J.F. 1998a. *Current issues in water management on-farm in relation to the rain-fed farming systems of N.E. India. A review of options*. DFID Research Project R6759. Centre for land use and water Resources Research (CLUWRR). Newcastle University.
- Barr, J. J. F. 1998b. *Systems Investigation of Livelihood Strategies and Resource Use Patterns on Bangladesh Floodplains*. In "Association for Farming Systems Research-Extension (AFSRE). 15th International Symposium", Vol. 2, pp. 994-1003, Pretoria, South Africa.
- Bhattacharjee, J.C. Roychowdhury, C. Landey, R.J. & Pandey, S. 1982 *Bioclimatic analysis of India*. National Bureau of Soil Survey (NBSS) & Land Use Planning (LUP) Bulletin. Indian Council of Agricultural Research (ICAR). Nagpur, India, NBSS LUP. 21pp.
- Carney, D. 1998. *Implementing the Sustainable Rural Livelihoods Approach*. In 'Sustainable Rural Livelihoods: What contribution can we make?' (D. Carney, ed.), pp. 3-23. DFID, London.
- Chakrabarty, R. D. 1982. *Polyculture - principles and practices*. *Journal of Inland Fisheries* 1, 30-40.
- Chambers, R. 1983. *Rural development: Putting the Last First*. 1st/Ed. Longman Scientific and Technical, London.
- DAS 1996 Tabulated data presented by Wayamba Development Authority, Kurunegala.
- Datt, G. 1997. *Some aspects of poverty in Sri Lanka: 1985-90*. Poverty and Human Resources Division. World Bank, Washington.
- Denzin, N.K. 1970. *The research act: A theoretical introduction to sociological methods*. Aldine publishing company. Chicago, USA. 368pp.
- De Silva., S. 1988. *Reservoirs of Sri Lanka and their fisheries*. FAO fisheries technical paper. Rome. 128pp.
- De Silva, K. G. H. M. 1991. *The predicament of the freshwater fisheries and aquaculture of Sri Lanka*. *NAGA the ICLARM quarterly* January 1991, pp 6-7.
- The Economist 2001. *The poor want answers*. The Economist. Jan 13th – 19th. pp. 71-72.
- Engleman, R and Leroy, P. 1993. *Sustaining water: population and the future renewable water supplies*. Population Action International, Washington D.C. 10pp.
- ESCAP 1997 *Women in Sri Lanka*. UN Statistical Profiles No. 13. New York.
- FAO 1995 Year book. UN Food and Agriculture Organisation, Rome.
- Felsing, M and Murray F.J. 1998 *Methods for participatory information gathering*. DFID Project 7064: 'Aquaculture in small-scale farmer managed irrigation systems'. Working Paper No. 1 Stirling University, Institute of Aquaculture. Unpublished. 25 pp
- Felsing, M and Murray, F.J. 1999 *Aquaculture in small-scale farmer managed irrigation systems*. DFID Project 7064 Inception report. Stirling University, Institute of Aquaculture. Unpublished.
- Gamage, H. 1997. *State of art and status of watershed management in Sri Lanka*. UNDP / FAO, Rome.
- Gowing, J. 1998 *Project inception report*. DFID Knowledge and research (KAR) Project 7123.

- Hasnip, N. 1999 *Poverty reduction and irrigated agriculture*. International Programme for Technology and Research in Irrigation and Drainage (IPTRID). Issues Paper No.1. January 1999. 19pp.
- Haylor, G. 1994 *Fish production in engineered water systems in developing countries*. In: 'Recent Advances in aquaculture V'. Eds. J. Muir and J. Roberts). Blackwell Science, London 1-103.
- Higgins, G.M. & Kassam, A.H. 1981. *The FAO agro-ecological approach to determination of land potential*. *Pedologie* XXX1 (2): 147-168.
- Kelegama, J.B. 1999. *The future of Sri Lanka's trade*: Keynote address to the annual sessions of the Sri Lanka Association of Economists 24/4/99. In 'The Island' newspaper. Colombo pp7.
- Kodithuwaku, S. S. 1997. *Entrepreneurial Processes in an apparently Uniform Context; A study of rural farmers in Sri Lanka*. PhD, Stirling University, Stirling.
- Lawrence, A., Haylor, G., Barahona, C., and Meusch, E. 1997. *Participatory indicators for farming systems change: matrices for learning in farmer-managed trials in Bolivia and Laos*. In 'International Workshop on Participatory Monitoring and Evaluation', pp. 18. AERDD Agricultural Extension and Rural Development Department, IRR, Philippines.
- Lawrence, A.J. Barr, J and Haylor, G. 1999 *Stakeholder approaches to planning participatory research by multi-institution groups*. ODI Agriculture Research Extension Network, AGREN. Network Paper 91. 9pp.
- Murray, F.J. and Little D. 1998. *Proceedings of stakeholder workshop on integrated aquaculture in irrigation systems*. DFID Project 7064: 'Aquaculture in small-scale farmer managed irrigation systems'. Working Paper No.1 Stirling University, Institute of Aquaculture. Unpublished. 104pp.
- Martin, A. and Sherrington, J. 1996 *Participatory research methods: Implementation, effectiveness and institutional linkages*. Natural Resources Institute. Paper for the socio-economic methodologies workshop 29-30 April. 1996. 45pp.
- Myrada and IRR. 1997. *Resource management in rainfed drylands; and information kit*. Myrada, Bangalore and International Institute or rural reconstruction, Silan, Cavite. Bangalore. 244pp.
- Narapalasingam, S. (1999). *Economic growth and human development in Sri Lanka*. In "The Island", pp. 8, Colombo.
- NBSS 1992. *Agro-ecological regions of India*. Technical Bulletin. NBSS publication 24. National Bureau of Soil Survey (NBSS) & Land Use Planning (LUP). Indian Council of Agricultural Research (ICAR). Nagpur. Oxford and IBH Publishing Co. Pvt. Ltd., New Dehli, India.
- Nigam, A., Gujja, B., Bandyopadhyay, J., and Talbot, R. 1998. *Fresh Water for India's Children and Nature. Learning from Local-level Approaches*. UNICEF & WWF, Delhi.
- Panaboke, C.R. 1998. *Agro Ecological Regions*. In Arunja's Atlas of Sri Lanka.
- Postel, S.L. 1992. Daily, G.D. Ehrlich P.R. 1996 *Human appropriation of renewable freshwater*. *Science* 271:785-788.
- Pretty, J.N. 1995. *Regenerating Agriculture. Policies and practice for sustainability and self reliance*. Earthscan Publications Ltd. London.
- Redding, T. A. M., A. B 1990. *Fish production in irrigation canals. A review*. Technical Report. No. 317. FAO, Rome.
- Siegel, S. and Castellan, N.J. 1988 *Nonparametric statistics for the behavioural sciences*. Second edition. McGraw-Hill International Book Company, Kogakushka Ltd. 312pp.
- Sinathamby, D., and Noguchi, C. 1997. *Rapid food and rural livelihood security assesment for dry zone households in Sri Lanka*. CARE International Sri Lanka, Colombo.
- Somasiri, S. 1991 *Irrigation potential of minor tanks and their agricultural stability*. *Tropical Agriculturalist*. Vol 147.
- Townsley, P. 1996. *Rapid Rural Appraisal, Participatory Rural Appraisal and aquaculture*. FAO Fisheries technical paper. No. 358 Rome. FAO. 109p

- Ulluwishewa, R. 1995. *Traditional practices of inland fishery resources Management in the Dry Zone of Sri Lanka: implications for sustainability*. Environmental conservation. 22. 2. 127-132.
- UNDP 1997 *Human Development Report*. New York. Oxford University Press.
- UNDP 1998 *National Human Development Report – Sri Lanka. Regional dimensions of human development*. United Nations Development Programme, Sri Lanka, Colombo. 88p.
- UNDP 2000 *Human Development Report*. New York. Oxford University Press.
- Wanasinghe, S. 1999. *Effective local governance*. The foundation for a functioning democracy in Sri Lanka. Institute of policy studies. Colombo. Sri Lanka. 51p.
- Weragoda, N. V. 1998. *Internal Trade*, in Arunja's Atlas of Sri Lanka. In "Internal Trade, in Arunja's Atlas of Sri Lanka" (S. T. and M. P. e. a. Perera, eds.), pp. 158-160.
- Wolf, E. C. 1986. *Beyond the green revolution: New approaches for third world agriculture*. Rep. No. 73. Worldwatch Institute, Washington D.C.

Appendix 1: The sustainable livelihoods framework:

An appreciation of the importance of participation in development, along with increased understanding of the role of the environment and an emphasis on sustainability, has recently led to the formulation of the Sustainable Livelihoods Framework. The 1997 UK White Paper³³ on International Development commits the Department for International Development (DFID) to promoting “sustainable livelihoods” and to protecting and improving the management of the natural and physical environment. These objectives are expected to contribute to an overall goal of poverty eradication (Carney 1998). Livelihoods can be said to comprise capabilities, assets (material and social) and activities required for a means of living. They are sustainable when they can withstand stresses and shocks and maintain or enhance capabilities and assets, both now and in the future, whilst not undermining the natural resource base.

A conceptual framework for sustainable livelihoods has been developed by the Institute for Development Studies (Scoones 1998). Livelihoods are described as built upon *Natural, Social, Human, Physical* and *Financial* capital assets vulnerable to trends, shocks and local cultural practices. Livelihoods are defined by *transforming structures* (e.g. institutions, government) and *processes* (e.g. laws/incentives) which determine who gains access to which type of asset, its effective value and thus which strategies and activities are attractive to whom. Aquaculture as a livelihood option may contribute to the robustness of, and increase the opportunities available to, individuals / groups / communities by building up their *asset* base.

The sustainable livelihood framework is shown in Figure 2.

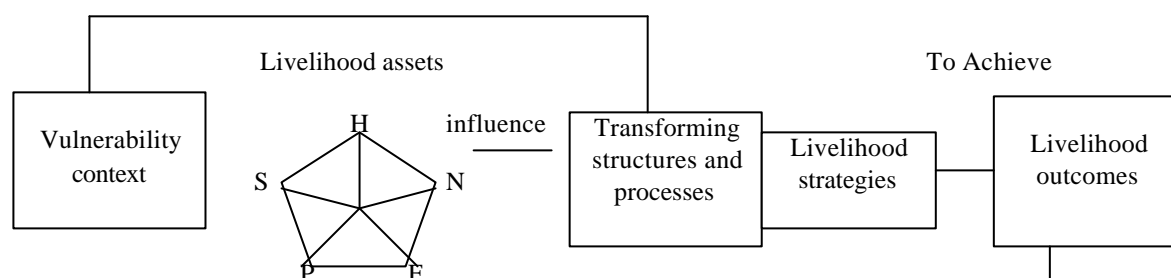

Figure 2: Sustainable livelihoods framework. Key: H = Human Capital, N = Natural Capital, F = Financial Capital, S = Social Capital, P = Physical Capital. Adapted from Carney (1998).

³³Eliminating World Poverty; A Challenge for the 21st Century. WhitePaper on International Development Presented to Parliament by the Secretary of State for International Development by Command of Her Majesty November 1997.

Appendix 2 Summary tables of climatic data.

Table A2.1 Monthly mean rainfall (mm) for 30 year normal periods in selected districts of the wet intermediate and dry zone. (Source: GoSL meteorological office).

Station	Anuradhapura	Hambantota	Matale	Kurunegala	Nura Eliya	Ratmalana
Zone	Dry	Dry	Intermediate	Intermediate	Wet	Wet
Jan	82.1	57.9	104.2	61.8	107.1	68
Feb	47.6	46.8	72.5	92.4	75.1	74.2
Mar	71	65.6	72.3	138.4	70.7	139.5
Apr	145.3	94.9	184.7	262.2	151.4	253.3
May	90.7	89	130.6	194.2	177.7	369.7
Jun	10.4	59.4	99.4	156.1	176.2	197.1
Jul	30.1	47.7	100.2	114.4	174.1	134.9
Aug	38.9	54.8	88.9	93.1	158.9	131.8
Sep	74.1	71.5	138.9	158.7	175.8	244.3
Oct	254.7	150.7	265.9	359.4	228.1	370.5
Nov	226.4	188.2	293.4	326.8	215.3	312.5
Dec	200.9	118.1	201.5	139.4	193.6	176.2
Total	1272.2	1044.6	1752.5	2096.9	1904	2472

Coordinates of the stations (Longitude (E);Latitude (N)) Source: IIMI 1998

Anuradhapura: 80.417: 8.367

Hambantota 81.133: 6.117

Matale80.633: 7.467

Kurunegala 80.35: 7.467

N'eliya 80.767: 6.967

Ratmalana79.883: 6.817

Table A2.2 Mean monthly rainfall and temperature data for selected districts in North West, North Central and Northern Provinces..

	Jan	Feb	Mar	Apr	May	Jun	Jul	Aug	Sep	Oct	Nov	Dec
Galgamuwa (mm)	60	33	30	132	89	14	18	27	63	199	226	123
Anamaduwa (mm)	64	43	53	175	106	52	27	50	86	275	248	97
Polpitiyagama (mm)	97	65	43	172	135	111	37	68	61	310	330	201
Kahatagasdigiliya(mm)	78	26	38	125	90	25	56	64	130	173	264	272
Polpitiyagama (Min. oC)	20.8	21.1	22.5	23.7	24.6	24.6	24.1	24.1	23.8	22.9	22.5	21.9
Polpitiyagama (Max. oC)	30.8	33.2	34.9	33.8	32.1	30.5	30.4	31.1	32.1	31.1	30.6	30.0

Source: GoSL Divisional Meteorological offices.

Appendix 3: Poverty indicators for districts within the lowland dry zone.

	Agro Ecological Zone ^e	Land Area (km ²)	Population (Per Km ²) 1995	GDP \$ Per Capita 1994	% Adult Illiteracy 1994	Schooling % Non Enrolment Grade 1-9	% Temp. Housing ⁵	% w/o Access to Electricity 1994	Unprotected water supply 1994 ²	% w/o Safe Sanitation 1994 ³	% Low Birth Weight 1996 ⁴	% Birth not in Institutions 1994	Infant Mortality (/1,000 Births) 1989	Within War Zone?
Central Province														
Matale	IZ & DL1	1,988	224	121	13.5	15.3	42.9	72.8	27.3	30	22.1	17.3	10.2	No
Southern Province														
Hambantota	DL 5 & DL1	2,593	206	113	13.1	12.6	42.1	74.4	28.3	26.4	14.6	15.9	5.2	No
Nothern Province														
Jaffna and Killinochi	DL3 & DL4	2,072	494						10.8	46.2	14.8	17.7	15	Yes
Mannar	DL3, DL4 & DL1	2,002	67						7.8	77.4	17.2	36.5	15	Yes
Vavunia	DL1	2,645	45						17.5	77.6	9.8	36.4	7.5	Yes
Mullaitivu	DL1 & DL3	1,966	50						33.8	83.9	15.9	44.7	10	Yes
Eastern Province														
Batticaloa	DL2	2,465	174						18.3	82.4	16.6	48.6	10	Yes
Ampara	DL2 & DL1	4,539	109						26.1	71.1	10.6	34.9	8.1	Yes
Trincomalee	DL1 & DL2	2,618	125						27.2	64.9	12.8	48.7	7.1	Yes
North-Western Province														
Kurunegala	WZ, IZ & DL1	4,773	312	141	8.8	12.8	43.5	76.6	27.5	46.1	19.4	10.9	16	No
Puttulam	WZ, IZ & DL1	2,977	209	116	7.3	6.3	42.8	60.1	28.3	62.2	17.1	14.7	17	No
North Central Prov														
Anuradhapura	DL1	7,129	103	172	9.6	6.4	46.3	67.4	36.7	59.6	21.6	15.3	19.4	No
Polonaruwa	DL1 & DL2	3,404	96	144	9.5	20.3	44.8	77.1	63.7	26.1	18.6	24.7	10.4	No
Uva Province														
Monoragale	IZ, DL1 & DL2	5,587	66	106	15.9	10.2	42.5	83.2	47.3	39	18.8	31.1	4.1	No
Country Mean/Total		64,652	279	141	8.9	8.7	33.5		27.9	33.5	18.2	78.3	18.4	

¹ DL = Dry Land Zone, IZ = Intermediate Zone, WZ = Wet Zone (see section 3.6.1). ² Households with access only to unprotected well or river supply. ³ Households without sealed, pit or bucket latrine. ⁴ Births below 2500g. ⁵ Housing of mud and cajun construction (Demographic housing survey, 1994, release 2). **Sources:** Annual Health Bulletin 1994/96, NHDR 1998, Medical Stats Unit 1996).

Appendix 4: Poverty and water resource indicators for divisional secretariats of North West, North Central and Northern Provinces.

Divisional Secretariat No	District & Divisional Secretariat (DS) Name	Agro-Ecological Zone	Km from Coast	Infant nutrition (under 5's)				% Temp House	Samurahi Total %	Tanks <500 ha	Tanks <500 ha	Mahaweli Development area ²¹
				Stunting %	Wasting %	Underweight %	Infant mortality /1,000 births					
	Puttalam			32.1	16.2	4.1	20.3					
1	Anamaduwa	DL1	20	11.1	21	9.8	1.8	56.8			no	
6	Karuwalagaswewa	DL1/DL3	12				3.4				no	
8	Mahakumbukkadawala	DL1/DL3	8	17.1	17.5	42.1	0				no	
12	Nawagattegama	DL1	27	32.4	21.3	56.5	0				no	
13	Pallama	DL3	5	26.5	22.3	49.9					no	
15	Wanathavilluwa	DL3	5	22.9	1.6	66.9	7.6				no	
	Kurunegala			26.7	17.5	8.4	19.6					
3	Galgamuwa	DL1/IL3	60				5.6				no	
5	Giribawa	DL1	44				6.8	84			no	
9	Kotawehera	DL1/IL3	33				6				no	
13	Mahawa	DL1	47								no	
22	Polpitiyagama	DL1/IL3	70	21.6	29.3	39.3	8.4				no	
	Nikaweratiya	DL1	31				3.3				no	
25	Mahagalkadawewa	DL1	38			44.5	16					
	Maho						8.7				no	
	Anuradhapura			29.6	22.3	6.8	21.3					
2	Galnewa	DL1	68	18.2	18.2	42.9	19.5	32	61	55	Yes (H)	
4	Ipalogama	DL1	82				3.2		61	50	Yes (H)	
7	Kakirawa	DL1	84				28.2		42	101	Yes (H)	
11	Nochiyagama	DL1	32				22.3	16	61	124	Partly (H)	

Divisional Secretariat No	District & Divisional Secretariat (DS) Name	Agro-Ecological Zone	Km from Coast	Infant nutrition (under 5's)				% Temp House	Samurधि Total %	Tanks <500 ha	Tanks <500 ha	Mahaweli Development area ¹
				Stunting %	Wasting %	Underweight %	Infant mortality /1,000 births					
15	Palagala	DL1	74				14.3		74	92		Partly (H)
16	Palugaswewa	DL1	102				0		63	11		No
17	Rajanganaya	DL1	41				12.2		45	NA	1	Yes (H)
19	Thalawa	DL1	63				29.3	28	54	50		Yes (H)
20	Tambuttegama	DL1	53				23.2	42	38	4	0	Yes (H)
	Galenbiduwewa	DL1							61	134	2	No
	Thirappane	DL1							78	208	2	No
	Horoupatana	DL1								220	0	No
	Matale			40.6	26.3	12	13.4		67			
2	Dambulla	DL1	97	15.8	21.6	37.9	11.3			76 (3)		Partly (H)
3	Galewela	DL1/IL3	80				6.3					No
	National average											

Data Sources:

Irrigation data: Mahaweli RPM office (1998)

Nutrition indicators: District and divisional values for stunting and wasting from 1988/89 Nutritional Status Survey (Min Health and FAO)

Infant mortality: Child and maternal mortality in Sri Lanka 1991(Registrar Generals office 1998).

Other Poverty indicators: District Secretariat Anuradhapura (1998) & Divisional secretariat of relevant districts visited.

Notes:

¹ Bracketed letter refers to Subsystem of Mahaweli Development programme.

Appendix 5: Key to locations included in cascade screening process (refer to Figure 11).

District	Divisional Secretariat ¹	Grama Nilhadiri ²	Cascade Name ³	Principle Villages ⁴	Ref no ⁵
Puttalam	Anamaduwa	Paramakanda	Pahla Diulwewa	PDW, Pahal Sembugama, Uttura Paliagama	1*
Puttalam	Anamaduwa	Koiladigama	Andarawewa	Andarawewa	14**
Kurunegala	Galgamuwa	Kumbukwewa	Danduwellawe	Dandulawellawe Ainkenda, Kumbuk	2*
Kurunegala	Galgamuwa	Nitalawa	Nitalawa	Nitagama	10
Kurunegala	Galgamuwa	Timbiriya	Bedigama	Bedigama	11
Kurunegala	Giribawa	Ihala Marankadawela	Ihala Marankadawela	IMK, Madurugama	5**
Kurunegala	Polpitiyagama	Mamunugama	Mamunugama	Mamunugama, Ihala Timbiriya	8
Kurunegala	Polpitiyagama	Saliyagama	Amunokole	Galkandegama, Amunokole	9
Matale	Dambulla	Ethabandawewa	Ethabandawewa	Ethabandawewa, Manikdena	3
Matale	Dambulla	Digamp atana	Digampatana	Digampatana	4
Anuradhapura	Tirappane		Mahakanamulla	Mahakanamulla	6
Anuradhapura	Tirappane		Pahala Ambathale	Phala Ambathale, Ihala Ambathale	7
Anuradhapura	Kahatagasdigiliya	Moraganawella	Moraganawella	Moraganawella	12
Anuradhapura	Nochchiyagama	Dambawelegama	Dambawelegama	Dambawelegama	13

¹ Administrative division covering 90 – 160 villages

² Lowest level administrative division covering 4 – 10 villages

³ Name of cascade system based on principal village upper cascade.

⁴ Villages visited during preliminary screening process.

⁵ Cascade reference no. refers to locations shown in Figure 11.

* Cascades selected for detailed preliminary Participatory Rural Appraisal (PRA).

** Cascades selected for follow-up longitudinal PRA study.

Appendix 6: Map showing location of cascade systems selected for in-depth study and Divisional secretariats of Kurunegala and Puttalam Districts

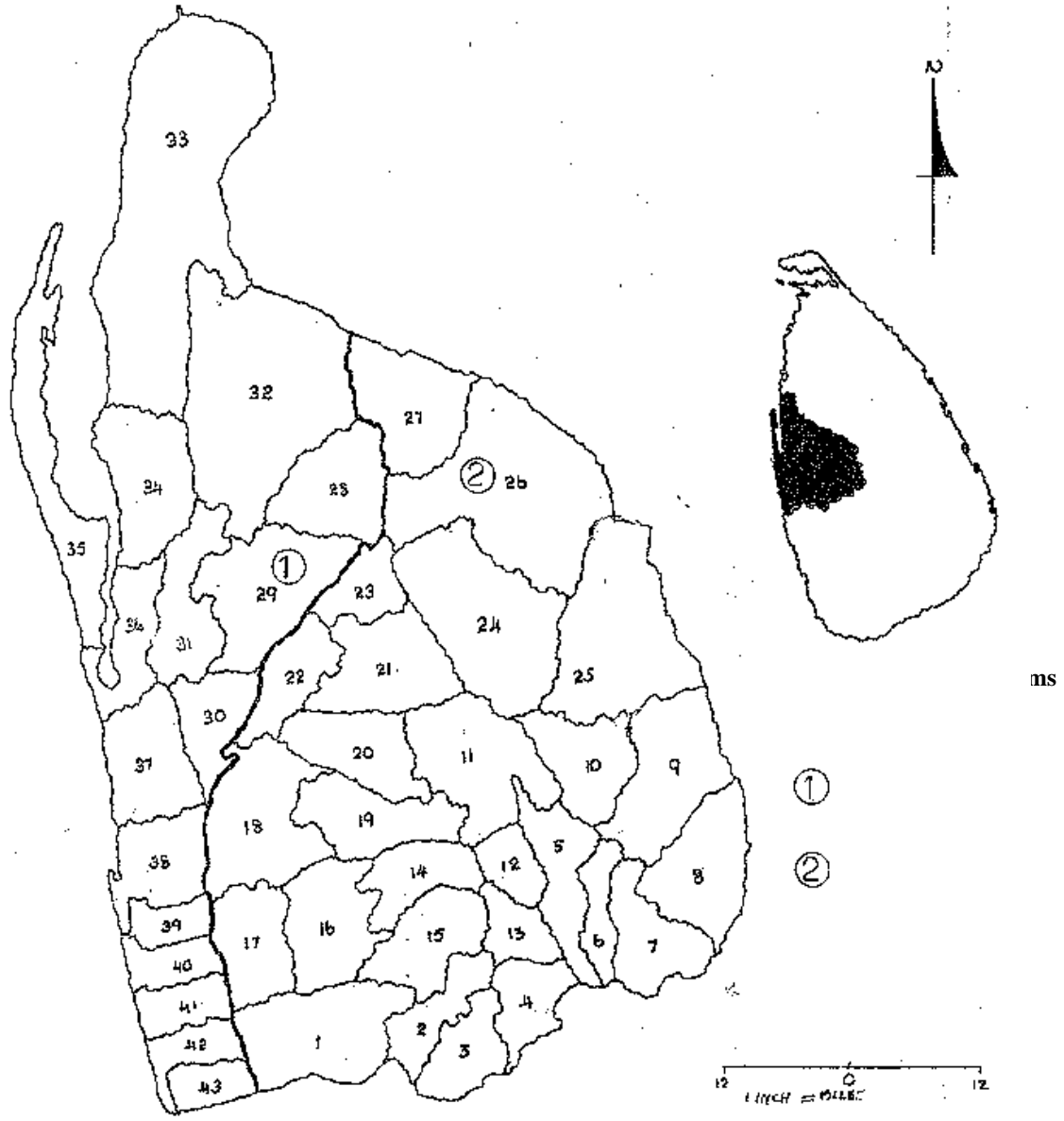

KURUNEGALA DISTRICT

- | | |
|--------------------|-----------------------|
| 1. PANNALA | 15. KULIYAPITTYA WEST |
| 2. NARAMMALA | 16. KULIYAPITTYA EAST |
| 3. ALAWWA | 17. UDUBADDAWA |
| 4. POLGAHAWELA | 18. BINGIRIYA |
| 5. KURUNEGALA | 19. HETTIPOLA |
| 6. MALLAWAPITTYA | 20. KOBEIGANE |
| 7. MAWATHAGAMA | 21. NIKAWERATTIYA |
| 8. RIDDEGAMA | 22. RASNAYAKAPURA |
| 9. IBBAGAMUWA | 23. KOTAWEHERA |
| 10. GANEWATTA | 24. MAHO |
| 11. WARIYAPOLA | 25. POLPITIGAMA |
| 12. MASPOTHA | 26. GALGAMUWA |
| 13. WEERAMEUGEDARA | 27. GIRIBAWA |
| 14. KATUPOTHA | |

PUTTALAM DISTRICT

- | | |
|-----------------------|----------------|
| 28. NAWAGATREGAMA | 41. NATTANDIYA |
| 29. ANAMADUWA | 42. WENNAPUWA |
| 30. PALLAMA | 43. DANKOTUWA |
| 31. MAHAKUMBUKADAWALA | |
| 32. KARUWALAGASWEWA | |
| 33. WANATHAWILLIWA | |
| 34. PUTTALAM | |
| 35. KALPITTYA | |
| 36. MUNDALAMA | |
| 37. ARACHCHIKATUWA | |
| 38. CHILAW | |
| 39. MADAMPE | |
| 40. MAHAWEWA | |

Appendix 7: The Mahaweli development programme

The Mahaweli Development Programme is the largest multipurpose national development programme ever launched in Sri Lanka. The major components are: Generation of hydropower, settlement of landless and unemployed families (relieving population pressure in the Southwest) and provision of irrigation facilities for the dry zone. This was to be achieved by developing the physical and social infrastructure required for human habitation and by harnessing the waters of the Mahaweli Ganga, the longest river in the country. Under a UNDP/FAO Master Plan, the creation of a total irrigated area of 365,000ha was envisaged over a 30year period. The 1977 Accelerated Mahaweli Programme (AMP) was a revision of the Master Plan that brought forward the completion date of four major upstream headworks to 1995 and saw the development of 60,000 ha of irrigated land during the same period. The development area is divided into projects A-M, locations of which are shown in Appendix 8. The figure also illustrates the fact that less than 50% of the irrigated area that was conceived in the original master plan has been developed to date.

System H: This is the focus area for the large-scale (KAR) engineering programme. Initiated in 1975 this system lies within the Kalawewa basin, the greater part of which is located in Anuradhapura District, with smaller areas in Kurunegala and Matale. By 1995 nearly 79,000ha of new lands had been developed for irrigated agriculture, or provided with assured water for both yala and maha cultivation seasons. An extent of 42,000ha of this area was under paddy cultivation in 1995. 31,800 families (including 24,000 farmer families) have been settled constituting a total population of 152,850. In addition to development of five old town (including the administrative centre Tambutegema) three new towns have been created. The system was used as a prototype for the development of the system C and B.

Water management committees with representation from the Department of Irrigation, the Ceylon Electricity Board, and the Mahaweli Authority of Sri Lanka have ultimate responsibility for water distribution. At the field level, decisions relating to water distribution, cropping patterns and area to be cultivated are jointly managed by the state (including various line agencies) and farmer organisations. Farmer participation is through an apex body of all farmer organisations in the scheme (this model applies to all major irrigation schemes including those out with the Mahaweli development area).

The Mahaweli project currently contributes 25% and 50% of national paddy and chilli production respectively. The project has focused on crop diversification and intensification programmes and paddy yields in Mahaweli areas exceed the national average. In few other areas is the possibility of double cropping assured. To address the needs of second and third generation farmers and those who cannot depend solely on agriculture, an Enterprise initiatives have been established including micro-credit and small business support services. Social development includes provision of basic infrastructure including health and education (with collaboration of local and national NGO's) and establishment of Community Development Centres that promote settler-training programmes.

Appendix 8: Map showing location of irrigation components of the Mahaweli Development Programme (Source Wanigaratne 1998).

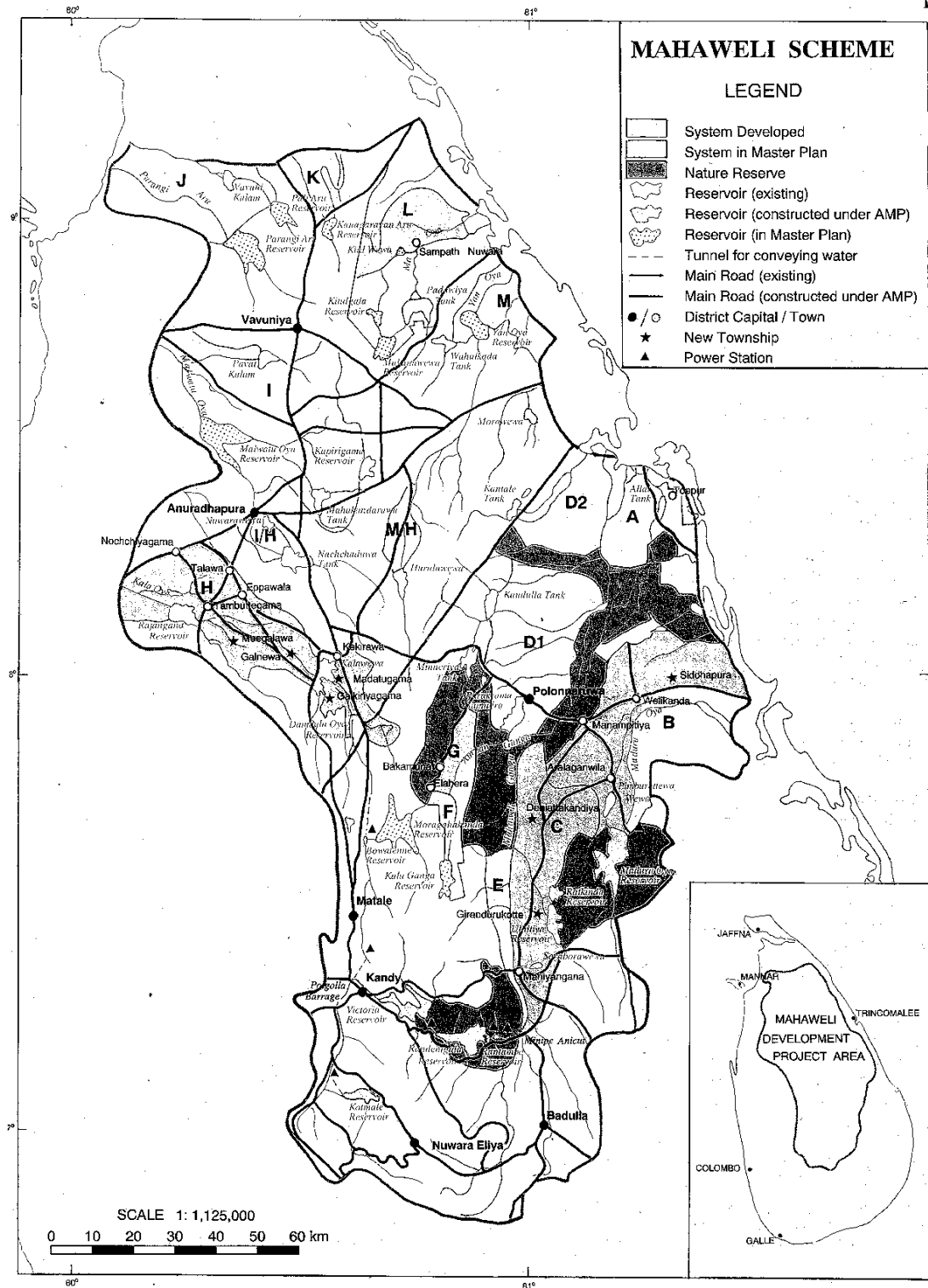

Appendix 9: Summary procedure for computing the Friedman two-way analysis of variance (Source: Felsing 1998).

1. Arrange the ranks in a two-way table having N rows (farmers) and k columns (parameters).
2. Determine the sum of the ranks in each column (R_j).
3. Calculate F_r using

$$F_r = \left[\frac{12}{Nk(k+1)} \sum_{j=1}^k R_j^2 \right] - 3N(k+1) \quad (7)$$

where

N = number of rows (farmers)

k = number of columns (parameters ranked)

R_j = sum of ranks in the j th column

$\sum_{j=1}^k$ = sum of squares of the sums of ranks over all conditions.

if there are no ties or

$$F_r = \frac{12 \sum_{j=1}^k R_j^2 - 3N^2 k(k+1)^2}{Nk(k+1) + \frac{N \sum_{i=1}^N \sum_{j=1}^k t_{i,j}^3}{(k-1)}} \quad (8)$$

where ϑ_i = the number of sets of tied ranks in the i th group

$t_{i,j}$ is the size of the j th set of tied ranks in the i th group.

If there are tied ranks in any row.

4. For small N and k , critical values of F_r can be found in a table of the Friedman two-way analysis of variance by ranks statistic, F_r (as found e.g. in Siegel & Castellan, 1988). For large N and / or k , use a table of critical values of Chi-square (e.g. as found in Siegel & Castellan, 1988) to find the associated probability from the χ^2 distribution, with $df = k - 1$.
5. If the probability is equal to or less than α , reject H_0 .
6. If H_0 is rejected, use multiple comparisons

$$|R_u - R_v| \geq z_{\alpha/k(k-1)} \sqrt{\frac{Nk(k+1)}{6}} \quad (9)$$

where $|R_u - R_v|$ = the differences between all pairs of parameters

Appendix 10: Statistical Tables of critical values for Friedman's test (Source Siegel and Castellan 1988).

Table A10.1: Friedman two-way analysis of variance by ranks statistic, F_r

k	N	α			
		$\leq .10$	$\leq .05$	$\leq .01$	
3	3	6.00	6.10		
	4	6.00	6.50	8.00	
	5	5.20	6.40	8.40	
	6	5.33	7.00	9.10	
	7	5.47	7.14	9.36	
	8	5.25	6.25	9.10	
	9	5.56	6.22	9.61	
	10	5.00	6.20	9.60	
	11	4.91	6.54	8.98	
	12	5.17	6.13	8.67	
	13	4.77	6.00	9.39	
	∞		4.61	5.99	9.21
	4	3	6.00	6.00	
4		6.60	7.40	8.60	
5		6.30	7.80	9.60	
6		6.36	7.80	9.96	
7		6.40	7.60	10.00	
8		6.26	7.80	10.17	
9		6.30	7.50	10.35	
∞			6.25	7.82	11.34
5	3	7.47	8.11	10.13	
	4	7.60	8.20	11.00	
	5	7.68	8.96	11.52	
	∞		7.78	9.49	11.28

* Some entries adapted and reproduced by permission of the publishers Charles Griffin & Co. Ltd. 16 Pembroke Road, London W11 1PL from appendix table 3 of Kendall, M. G. (1970) *Rank correlation methods* (fourth edition). Other entries adapted from table A.15 of Hollander, M. and Wolfe, D. A. (1973) *Nonparametric statistics*. New York: J. Wiley. Reproduced by permission of the authors and publishers.

Table A10.2: Critical z values for #c multiple comparisons. For values of #C outside of the range included in the table refer to table A10.3.

#C	α					
	Two-Tailed		One-Tailed			
	.30	.25	.20	.15	.10	.05
1	1.036	1.150	1.262	1.440	1.645	1.960
2	1.440	1.534	1.645	1.780	1.960	2.241
3	1.645	1.732	1.834	1.960	2.128	2.394
4	1.780	1.863	1.960	2.080	2.241	2.498
5	1.881	1.960	2.054	2.170	2.326	2.576
6	1.960	2.037	2.128	2.241	2.394	2.638
7	2.026	2.100	2.189	2.300	2.450	2.690
8	2.080	2.154	2.241	2.350	2.498	2.734
9	2.128	2.200	2.287	2.394	2.539	2.773
10	2.170	2.241	2.326	2.432	2.576	2.807
11	2.208	2.278	2.362	2.467	2.608	2.838
12	2.241	2.301	2.394	2.498	2.638	2.866
15	2.326	2.394	2.475	2.576	2.718	2.933
21	2.450	2.515	2.593	2.690	2.828	3.038
28	2.552	2.615	2.690	2.785	2.913	3.125

#C is the number of comparisons

Table A10.3: Probabilities associated with the upper tail of the normal distribution under H_0 of z . The left hand column gives values of z to one decimal place & the top row to two decimal places.

z	.00	.01	.02	.03	.04	.05	.06	.07	.08	.09
.0	.5000	.4960	.4920	.4880	.4840	.4801	.4761	.4721	.4681	.4641
.1	.4602	.4562	.4522	.4483	.4443	.4404	.4364	.4325	.4286	.4247
.2	.4207	.4168	.4129	.4090	.4052	.4013	.3974	.3936	.3897	.3859
.3	.3821	.3783	.3745	.3707	.3669	.3632	.3594	.3557	.3520	.3483
.4	.3446	.3409	.3372	.3336	.3300	.3264	.3228	.3192	.3156	.3121
.5	.3085	.3050	.3015	.2981	.2948	.2912	.2877	.2843	.2810	.2776
.6	.2743	.2709	.2676	.2643	.2611	.2578	.2546	.2514	.2483	.2451
.7	.2420	.2389	.2358	.2327	.2296	.2266	.2236	.2206	.2177	.2148
.8	.2119	.2090	.2061	.2033	.2005	.1977	.1949	.1922	.1894	.1867
.9	.1841	.1814	.1788	.1762	.1736	.1711	.1685	.1660	.1635	.1611
1.0	.1587	.1562	.1539	.1515	.1492	.1469	.1446	.1423	.1401	.1379
1.1	.1357	.1335	.1314	.1292	.1271	.1251	.1230	.1210	.1190	.1170
1.2	.1151	.1131	.1112	.1093	.1076	.1058	.1038	.1020	.1003	.0986
1.3	.0968	.0951	.0934	.0918	.0901	.0885	.0869	.0853	.0838	.0823
1.4	.0808	.0793	.0778	.0764	.0749	.0735	.0721	.0708	.0694	.0681
1.5	.0668	.0655	.0642	.0630	.0618	.0606	.0594	.0582	.0571	.0560
1.6	.0548	.0537	.0526	.0516	.0505	.0495	.0485	.0475	.0465	.0455
1.7	.0446	.0436	.0427	.0418	.0409	.0401	.0392	.0384	.0376	.0367
1.8	.0359	.0351	.0344	.0336	.0329	.0322	.0314	.0307	.0301	.0294
1.9	.0287	.0281	.0274	.0268	.0262	.0256	.0250	.0244	.0239	.0233
2.0	.0228	.0222	.0217	.0212	.0207	.0202	.0197	.0192	.0188	.0183
2.1	.0179	.0174	.0170	.0166	.0162	.0158	.0154	.0150	.0146	.0143
2.2	.0139	.0136	.0132	.0129	.0125	.0122	.0119	.0116	.0113	.0110
2.3	.0107	.0104	.0102	.0099	.0096	.0094	.0091	.0089	.0087	.0084
2.4	.0082	.0080	.0078	.0075	.0073	.0071	.0069	.0068	.0066	.0064
2.5	.0062	.0060	.0059	.0057	.0055	.0054	.0052	.0051	.0049	.0048
2.6	.0047	.0046	.0044	.0043	.0041	.0040	.0039	.0038	.0037	.0036
2.7	.0035	.0034	.0033	.0032	.0031	.0030	.0029	.0028	.0027	.0026
2.8	.0025	.0025	.0024	.0023	.0023	.0022	.0021	.0021	.0020	.0019
2.9	.0019	.0018	.0018	.0017	.0016	.0016	.0016	.0015	.0014	.0014
3.0	.0013	.0013	.0013	.0012	.0012	.0011	.0011	.0011	.0010	.0010
3.1	.0010	.0009	.0009	.0009	.0008	.0008	.0008	.0008	.0007	.0007
3.2	.0007									
3.3	.0006									
3.4	.0005									
3.5	.0003									
3.6	.0002									
3.7	.0001									
3.8	.0000									
3.9	.0000									
4.0	.0000									

Selected significance levels for the normal distribution

Two-tailed α	.20	.10	.05	.02	.01	.002	.001	.0005	.0001
One-tailed α	.10	.05	.025	.01	.005	.001	.0005	.0002	.00005
z	1.282	1.645	1.960	2.326	2.576	3.090	3.291	3.891	4.417